



101 Lucas Valley Road, Suite 300
San Rafael, CA 94903
Tel.: 415-472-1734
Fax: 415-499-7715
www.LGVSD.org

MANAGEMENT TEAM
General Manager, Curtis Paxton
Plant Operations, Mel Liebmann
Collections/Safety/Maintenance, Greg Pease
Engineering, Michael P. Cortez
Administrative Services, Dale McDonald

DISTRICT BOARD
Megan Clark
Craig K. Murray
Barry Nitzberg
Gary E. Robards
Crystal J. Yezman

CONTRACT DOCUMENTS REQUEST FOR INFORMAL BIDS (UNIFORM PUBLIC CONSTRUCTION COST ACCOUNTING ACT)

Bid Item: Center Pivot No. 3 Replacement (Job Number 25580-01)

Description: Replacement of existing 790'-diameter Center Pivot No. 3 irrigation system and ancillary components.

Bid Opening Time, Date & Location: **11:00 AM, September 6, 2024**
101 Lucas Valley Road, Suite 300, San Rafael, CA 94903

Contents:

- Acknowledgement (page 3)
- Notice Inviting Informal Bids (p. 5)
- Instruction to Bidders (p. 7)
- Bidder's Checklist: (p. 11)
 - Proposal and Bid Schedule (p. 13)
 - Bid Bond (p. 17)
 - Non-Collusion Affidavit (p. 19)
 - Statement of Compliance (p. 21)
 - Hazardous & Toxic Substances Disclosure Requirements
 - Bidder's Signature Page (p. 25)
- Contractor Agreement (p. 27)
 - General Conditions (p. 36)
 - Performance Bond (p. 123)
 - Payment/Labor and Materials Bond (p. 125)
 - 2-Year Maintenance Bond (p. 127)
- Technical Specifications (Not Used)
- As-Built Drawings & Reference Photo (p. 130)



Pursuant to UPCCAA procedures, interested bidders must be prequalified by the District prior to submitting an informal bid for projects under \$200,000 such as this Project. Failure to do so will disqualify the bidder. If you would like your company prequalified, please complete and sign a Contractor's Pre-Qualification Application available at <https://www.lgvsd.org/upccaa-contractor-pre-qualifications> and submit to the District before the bid opening shown above.

Responses to this invitation from prequalified bidders must be received by District no later than the date and time and at the place shown above for consideration. Electronic copies are acceptable if followed by a phone call to the District at 415-472-1734 confirming receipt prior to the bid opening time. Email to: Michael P. Cortez at mcortez@lgvsd.org and cc: Irene Huang at ihuang@lgvsd.org.

THIS PAGE INTENTIONALLY LEFT BLANK

ACKNOWLEDGEMENT

ACKNOWLEDGEMENT OF THE CONTRACT DOCUMENTS MUST BE RECEIVED BY THE DISTRICT IN ORDER FOR YOU TO RECEIVE ADDENDUMS (i.e., updates or changes to the Contract Documents). PLEASE COMPLETE BELOW AND FAX TO 415-499-7715, OR EMAIL TO pquinn@lgsd.org IMMEDIATELY UPON RECEIPT OF THIS PACKET so that you will receive any changes or updates as they occur. If we do not receive this form from you, any updates or changes that you do not receive are not the responsibility of the District.

Bid Item: **CENTER PIVOT NO. 3 REPLACEMENT**

Date Received: _____

Recipient: _____ (BIDDER)
_____ (ADDRESS)

_____ (PHONE)
_____ (FAX)
_____ (EMAIL)

Printed Name

Signature

THIS PAGE INTENTIONALLY LEFT BLANK

LAS GALLINAS VALLEY SANITARY DISTRICT
101 Lucas Valley Road, Suite 300
San Rafael, California 94903

NOTICE INVITING INFORMAL BIDS

1. The Las Gallinas Valley Sanitary District hereby invites informal bids for the **CENTER PIVOT NO. 3 REPLACEMENT** Project, in accordance with the Uniform Public Construction Cost Accounting Act (UPCCAA) Procedures and other applicable law, and the following:
2. All bids must be delivered to the **Las Gallinas Valley Sanitary District administrative office located at 101 Lucas Valley Rd, Suite 300, San Rafael, California 94903** on or before **11:00 AM, September 6, 2024**. Bids will be announced and read publicly at that time. Bids must be made on the bid forms included in the bid package. Bids that are submitted late according to the official time kept by the District Engineer or a designee will be rejected. Bids that are incomplete or that otherwise do not conform to the requirements specified in the bid package may be deemed non-responsive. Electronic copies are acceptable if followed by a phone call to the District at 415-472-1734 confirming receipt prior to the bid opening time. Email to: Michael P. Cortez at mcortez@lgsd.org and cc: Irene Huang at ihuang@lgsd.org no later than the date and time shown above for consideration.
3. Pursuant to UPCCAA procedures, interested bidders must be prequalified by the District prior to submitting an informal bid for projects under \$200,000 such as this Project. Failure to do so will disqualify the bidder. If you would like your company prequalified, please complete and sign a Contractor's Pre-Qualification Application available at <https://www.lgsd.org/upccaa-contractor-pre-qualifications> and submit to the District before the bid opening shown above.
4. A pre-bid meeting is scheduled for **August 22, 2024 at 10:00AM, 101 Lucas Valley Rd, Suite 300, San Rafael, California 94903**. The pre-bid meeting is **non-mandatory**. Special site visits may be scheduled 24 hours in advance a minimum of five (5) working days before bid opening.
5. Questions regarding the bid package should be directed in writing as soon as possible (but no later than five (5) working days prior to the opening of bids to: Michael P. Cortez, PE at mcortez@lgsd.org and Irene Huang, PE at ihuang@lgsd.org or 415-472-1734. Where appropriate, the District may respond to such questions by addenda transmitted to all bid package recipients.
6. The Project Contractor shall furnish all tools, equipment, apparatus, facilities, labor and material necessary to perform and complete in a good and workmanlike manner the construction of the **CENTER PIVOT NO. 3 REPLACEMENT** Project as shown in the Project Technical Specifications and Drawings and in accordance with the Contract Documents within **60 calendar days** of the Project commencement date specified in the Notice to Proceed for the Project. The Engineer's estimate is **\$175,000**.
7. SCOPE OF WORK. The Project work is generally described as:
 - a. Replacement of existing 790'-diameter Center Pivot No. 3 irrigation system and ancillary components.
 - b. Startup and testing.
8. All the project work shall be completed in accordance with the bid packages on file at the District. Complete bid packages may be obtained at <https://www.lgsd.org/call-for-bids> or **Engineering Department, Las Gallinas Valley Sanitary District, 101 Lucas Valley Road, Suite 300, San Rafael, California 94903**.
9. In accordance with California Business and Professions Code Section 7028.15, all Project work must be

performed by properly licensed contractors and subcontractors with active licenses in good standing as of the date and time specified for bid opening.

10. In accordance with California Labor Code Section 1771, not less than the general prevailing rate of per diem wages for work of a similar character in the locality in which the project is to be performed, and not less than the general prevailing rate of per diem wages for holiday and overtime work fixed as provided in the California Labor Code shall be paid to all workers engaged in performing the project. In accordance with California Labor Code Section 1770 and following, the Director of Industrial Relations has determined the general prevailing wage per diem rates for work in the locality in which the project is to be performed. In accordance with California Labor Code Section 1773, the District has obtained the general prevailing rate of per diem wages and the general rate for holiday and overtime work in the locality in which the project is to be performed for each craft, classification or type of worker needed to perform the project. In accordance with California Labor Code Section 1773.2, copies of the prevailing rate of per diem wages are on file at the District Engineer's Office and will be made available on request. A copy of said wage rates is available online at www.dir.ca.gov/DLSR/PWD. In accordance with California Labor Code Section 1777.1, contractors and subcontractors that are found guilty of willfully violating Chapter 1 of Part 7 of Division 2 of the Labor Code (except for Section 1777.5), or that are found guilty of such violations with intent to defraud, and entities in which such contractors or subcontractors have any interest, may be ineligible to bid on, be awarded, or perform Project work as a subcontractor.
11. All bids will remain valid for sixty (60) calendar days after the bid opening. Except as permitted by law and subject to all applicable remedies, including forfeiture of bidder's security, bidders may not withdraw their bid during the sixty (60) day period after the bid opening.

Las Gallinas Valley Sanitary District

By: /s/ Michael P. Cortez
Michael P. Cortez, PE, District Engineer

Date: August 9, 2024

INSTRUCTIONS TO BIDDERS

1. DEFINITIONS:

The following words, terms and phrases, when used in this document, shall have the following meaning:

Bidder means the individual, firm, partnership or corporation offering a bid in response to this Notice Inviting Informal Bids. The terms Contractor and seller are synonymous with Contractor or seller.

District means the Las Gallinas Valley Sanitary District and its authorized agents. The terms owner or buyer are synonymous with District.

Contractor means the individual, firm, partnership or corporation to whom a contract or purchase order is awarded as a result of this Notice Inviting Informal Bids.

Bid forms. The bid forms are the forms contained in the Contract Documents.

The **Project** is the CENTER PIVOT NO. 3 REPLACEMENT as described in the Technical Specifications and Drawings.

The **Technical Specifications** provide detailed requirements concerning the Project and are contained in the Contract Documents.

2. BIDDER'S REPRESENTATIONS

Each bidder by submitting a bid represents that:

- 2.1 The bidder has read and understands the Contract Documents and the bid is in accordance with all of the requirements of the Contract Documents and applicable law.
- 2.2 Neither the bidder nor any subcontractor is ineligible to perform work on public works projects pursuant to California Labor Code Sections 1777.1 or 1777.7.

3. AWARD

- 3.1 In accordance with applicable law, the District reserves the right to reject any or all bids and to waive any informality in any bid. The District reserves the right to accept any portion of any bid, unless the Contract Documents expressly provides that the award will be made as a whole. If the District elects to award a contract for performance of the Project, the contract will be awarded in accordance with California Public Contract Code Section 20803 and other applicable law to the responsible bidder submitting a responsive bid with the lowest total bid price for the base bid and the additive or deductive alternate items listed in the Notice Inviting Informal Bids. In accordance with the Contract Documents and other applicable law, the District may add or deduct items of work from the Project after the lowest responsible bidder is determined.
- 3.2 The successful bidder must submit to the District complete, executed copies of all documents within seven (7) calendar days of receiving written Notice of Award of the Project. Bidder's security of any successful bidder that fails to do so will be forfeited to the District.

3.3 The successful bidder and any subcontractors and others engaged in performance of the Project must have a valid local business license(s), as applicable, before commencing work on the Project.

4. TAXES

The successful bidder shall pay the State of California sales tax to the California State Board of Equalization, if any, when due and payable.

5. ASSIGNMENT

Bidders may not assign, sublet, sell, transfer, or otherwise dispose of their bid or any right, title or interest in their bid, or their obligations under their bid, without the written consent of an authorized representative of the District. Any purported assignment, subletting, sale, transfer or other disposition of a bid or any interest in a bid, or of any obligations under a bid without such written consent will be void and of no effect.

6. PRICING

Prices must be submitted on a firm, fixed price basis. Unit prices are to be extended and a total price shown on all bids. If unit prices and extensions thereof do not coincide, the District will assume the price most favorable to the District to be the correct price. Bids not prepared properly may not be considered for evaluation. If Bidder wishes to quote lower unit prices for the award of groups of items, Bidder may do so as an alternate to Bidder's base bid. If applicable, Bidder is to include impact to pricing for quantity additions and/or deletions.

7. DELIVERY CHARGES

Delivery to be FOB San Rafael Freight Prepaid unless indicated differently. Contractor to show freight charges (if not included in price) on bid form as part of bid. Freight cannot be added after the bid is opened. Earliest delivery time that can be accomplished should be shown as delivery time may be a factor in awarding bid.

8. PRODUCTS

All products offered, unless otherwise specified, must be new and of the latest design and production. It must be complete, ready to use or operate with all the normal and usual features and capabilities.

The District shall consider the Contractor to have not completed his obligations until all literature (operators manual, instructions, service manuals, parts manuals, owner manual) that is normally provided with the product or has been requested in the bid has been received.

9. INSURANCE (See GENERAL CONDITIONS OF THE CONTRACTOR AGREEMENT)

10. INSPECTION & TESTING

The District reserves the right to test or inspect proposed bid items in order to determine the lowest responsive bidder.

11. WARRANTIES

Guarantees and warranties (if any) should be attached as a part of the bid as they may be a consideration in determining the lowest responsible bidder and in awarding a bid or contract.

12. IDENTICAL BIDS

In the event of two or more identical low bids, the contract may be awarded arbitrarily or for any reason to any of such bidders or split in any proportion between the Bidders at the discretion of the District.

13. AMBIGUITY IN BID

Any ambiguity in any bid as the result of omission, error, lack of clarity or noncompliance by the Bidder with specifications, instructions and all conditions of bidding shall be construed in the light most favorable to the District.

14. ADDITIONAL INFORMATION

All Bidders must be prepared to, at the request of the District, furnish, within ten working days of the request, additional information as may be sought so that the District can determine responsiveness.

15. TERMS OF PAYMENT

Bidder shall clearly state the proposed terms of payment, if different from the District's preference. The District's preferred term of payment is Net 30 days. Discount terms will be accepted. Progress payments will be considered if tied to specific milestones.

16. PUBLIC INFORMATION

All bids, documents, correspondence and material submitted to the District are considered public information and, as such, are subject to viewing and copying by the general public.

17. BIDDER TERMS

Other terms or conditions prepared by Bidder may or may not be considered by the District in awarding the bid. The District reserves the right to accept or reject any Bidder's proposed terms and conditions or any part thereof.

18. COLLUSION

Submission of a signed bid shall constitute certification by the Bidder that their bid is being submitted without collusion or agreement with any competitor.

19. THE DISTRICT'S RIGHTS

The District reserves the right to reject any or all bids, to waive minor irregularities and/or formalities as determined by the District, to award the bid by item or groups of items or in total, and/or to award the bid in the manner most advantageous to the District. The District reserves the right to, at its discretion, purchase additional units, within a reasonable time, at the bid unit price, upon concurrence of the bidder.

THIS PAGE INTENTIONALLY LEFT BLANK

BIDDER'S CHECKLIST

Name of Bidder: _____
(Contractor's Legal Name)

Did You:

_____ Send a properly completed Acknowledgement form immediately after receiving the Contract Documents and before bid opening.

_____ Include with your bid the following properly completed, accurate copies of the following documents in the following order using the forms included in the Contract Documents:

_____ Bidder's Check List

_____ Proposal and Bid Schedule

_____ Acknowledgement of each addendum issued by the District, if any, with signed and dated acknowledgement page.

_____ Executed Bid Bond

_____ Non-Collusion Affidavit

_____ Statement of Compliance

_____ Hazardous and Toxic Substances Disclosure Requirements

_____ Executed Bidder's Signature Page

_____ Arrange to have the bid delivered to the Las Gallinas Valley Sanitary District offices at 101 Lucas Valley Rd, Suite 300, California 94903, or emailed to: Michael P. Cortez at mcortez@lgsd.org and cc: Irene Huang at ihuang@lgsd.org, before the time and day specified on the Notice Inviting Informal Bids.

THIS PAGE INTENTIONALLY LEFT BLANK

PROPOSAL AND BID SCHEDULE

TO THE BOARD OF DIRECTORS OF THE LAS GALLINAS VALLEY SANITARY DISTRICT:

Pursuant to the Notice Inviting Informal Bids for the CENTER PIVOT NO. 3 REPLACEMENT, the person signing the bidder's signature page contained in this proposal binds the entity listed on the bidder's signature page to submit complete, executed copy of the CONTRACTOR AGREEMENT within seven (7) calendar days of receiving written Notice of Award of the Project, and to fully perform the Project by the time for completion specified in the Contract Documents for the price specified in the bid schedule below in accordance with the terms of the Contract Documents and applicable law. This proposal cover page and bid schedule will be included as part of the CONTRACTOR AGREEMENT in accordance with the Contract Documents.

This bid includes properly completed, accurate copies of all of the documents listed in the Bidder's Check List included in the Contract Documents in the order listed in the Bidder's Check List and using the forms included in the Contract Documents. This bid includes copies of each of the following addenda issued by the District. Each addendum has been signed and dated to confirm receipt on behalf of the entity listed on the bidder's signature page.

Addendum No. 1 dated _____	Addendum No. 2 dated _____
Addendum No. 3 dated _____	Addendum No. 4 dated _____
Addendum No. 5 dated _____	Addendum No. 6 dated _____

SCHEDULE OF LUMP SUM BID ITEMS: (Lump Sum Bid Items 1-3):

1. Mobilization, Demobilization, and General Conditions: Lump sum price for preparatory work and operations and establishment of other facilities necessary to work on the Project, including but not limited to labor compliance, prevailing wage compliance, all General Conditions requirements, demobilization, cleanup, and surface restoration to the satisfaction of the District at the completion of the Project.

Lump Sum Price: \$ _____
(In figures)

2. Furnish and install Center Pivot No. 3 irrigation system package, complete in place, including but not limited to freight, all applicable taxes, and labor, and the following:
 - a. Heavy Duty Tower Assembly (Reinke Tower 3-Wheel Rigid EII, or equal)
 - b. Pivot Center (Reinke, or equal)
 - c. Piping spans and trussing support (Reinke, or equal)
 - d. End Boom (~50' Reinke, or equal) with 5 HP booster pump.
 - e. Up to ten sprinkler hose booms (Boombacks, or equal), one on each side of each tower.
 - f. Low drift nozzles (Senninger, or equal)
 - g. Touch screen panel with enclosure (Reinke, or equal)
 - h. 8" flowmeter programmed with the touch screen panel.
 - i. Seven ¾" electric valves (XCAD, or equal), including wiring and fittings, programmed with the touch screen panel.
 - j. Other components necessary to ensure a functional system.
 - k. Supply Line Modifications:
 - i. Removal of existing tee, butterfly valve, solenoid valve, miscellaneous piping and fittings.
 - ii. Addition of 10" spacer flanges.
 - iii. Reinstallation of existing 10" tee, butterfly valve, and reducing spool.
 - iv. Addition of new gear operated electric 8" butterfly valve, new 8" pipe, and 8" dresser coupling.
 - l. Sheeting, Shoring, Bracing: The cost for planning, design, engineering fees, labor, materials, equipment, furnishing and constructing, and removal and disposal of such sheeting, shoring, and bracing, or equivalent method for the protection of life and limb in trenches and open excavation for all project sites in accordance with the requirements of OSHA and applicable safety orders, pursuant to the provisions Section 6707 of the California Labor Code.

Lump Sum Price: \$ _____
(In figures)

3. Demolition and disposal of the existing Center Pivot No. 3 irrigation system package and ancillary components (select **one** of the two options below).

a. Add (if no trade-in value): \$ _____, **or**
(In figures)

b. Deduct (if disposing and with higher trade-in value): \$ _____
(In figures)

TOTAL BASE BID, BASIS OF AWARD (SUM OF BID ITEMS 1-3):

\$ _____
(In figures)

THIS PAGE INTENTIONALLY LEFT BLANK

BID BOND

(NOTE: Bidders must use this form, or use of any other bid bond form may render a bid non-responsive)

KNOW ALL MEN BY THESE PRESENTS:

That we, as PRINCIPAL, and _____, a (sole proprietorship /corporation/partnership/joint venture) organized and existing under and by virtue of the laws of the State of _____ and an admitted surety insurer authorized to do business in the State of California, as SURETY, are held and firmly bound unto the Las Gallinas Valley Sanitary District, as OBLIGEE, in a penal sum equal to ten-percent (10%) the total bid price including the base bid and alternates specified in the proposal of the PRINCIPAL, to the OBLIGEE for the work described below, which penal sum is _____ (\$ _____) lawful money of the United States of America, for the payment of which sum well and truly to be made, we, and each of us, bind ourselves, our heirs, executors, administrators, successors, and assigns, jointly and severally, firmly by these presents.

THE CONDITION OF THIS OBLIGATION IS SUCH that whereas the PRINCIPAL has submitted the accompanying proposal dated _____, _____ to the OBLIGEE, for the CENTER PIVOT NO. 3 REPLACEMENT.

NOW THEREFORE, if the PRINCIPAL shall not withdraw said proposal within the ninety (90) day period following the opening of bids, and if the PRINCIPAL receives written notice that the CENTER PIVOT NO. 3 REPLACEMENT, is awarded to the PRINCIPAL and shall, within seven (7) calendar days of receiving such notice: enter into a written contract with the OBLIGEE in the form prescribed in the Contract Documents issued by the OBLIGEE concerning the CENTER PIVOT NO. 3 REPLACEMENT; and give insurance and bond with good and sufficient sureties guaranteeing the faithful performance and proper fulfillment of such contract and guaranteeing payment for labor and materials used for performance of the contract as required by law; and file with the OBLIGEE all required documents and do all other thing required in accordance with the Contract Documents issued by the OBLIGEE concerning the CENTER PIVOT NO. 3 REPLACEMENT, for the contract between the PRINCIPAL and the OBLIGEE to become effective and for work to commence in accordance with the Contract Documents issued by the OBLIGEE concerning the CENTER PIVOT NO. 3 REPLACEMENT, or, in the event of withdrawal of the accompanying proposal within the sixty (60) day period following the opening of bids; or failure by the PRINCIPAL to enter into such contract with the OBLIGEE or to give the OBLIGEE such bonds or to file any other documents or to do any other things required in the Contract Documents issued by the OBLIGEE for the CENTER PIVOT NO. 3 REPLACEMENT, if the PRINCIPAL shall pay the OBLIGEE the difference between the total bid price in the accompanying proposal and the amount for which the OBLIGEE may procure the required performance, if the latter amount be in excess of the former, together with all costs incurred by the OBLIGEE in again attempting to let the CENTER PIVOT NO. 3 REPLACEMENT and if the said PRINCIPAL shall fully reimburse and save harmless the OBLIGEE from any damage sustained by the OBLIGEE through failure of the PRINCIPAL to enter into the written contract or to file the required performance or labor and material bonds, or to file any other required documents or to do any other things required for the contract between the PRINCIPAL and the OBLIGEE to become effective and the work to commence in accordance with the Contract Documents issued by the OBLIGEE concerning the CENTER PIVOT NO. 3 REPLACEMENT, then this obligation shall be null and void; otherwise, it shall be and remain in full force and effect.

SURETY, for value received, hereby stipulates and agrees that no change, extension of time, alteration or addition to the terms of the bid or contract for the CENTER PIVOT NO. 3 REPLACEMENT, or to the specifications included in the same, or to the work to be performed there under, or to the notice to bidders, or to any other documents concerning the CENTER PIVOT NO. 3 REPLACEMENT, shall in anywise affect SURETY's

obligation under this bond, and SURETY hereby waives notice of any such change, extension of time, alteration or addition to such bid or contract.

In the event suit is brought upon this bond by the OBLIGEE and judgment is recovered, the SURETY shall pay all costs incurred by the OBLIGEE in such suit, including a reasonable attorney's fee to be fixed by the Court.

IN WITNESS WHEREOF, the above-bound parties have executed this instrument under their several seals this _____ day of _____, _____, the name and corporate seals of each corporate party being hereto affixed and these presents duly signed by their undersigned representatives, pursuant to authority of their governing bodies.

(Corporate Seal)

PRINCIPAL _____

By _____

(Acknowledgement)

Title _____

(Corporate Seal)

SURETY _____

By _____

(Attorney-in-fact)

(Acknowledgement)

Title _____

(NOTE TO SURETY COMPANY: A certified copy of unrevoked resolution of authority for the attorney-in-fact must be submitted with and attached to the executed bid bond.)

THIS PAGE INTENTIONALLY LEFT BLANK

STATEMENT OF COMPLIANCE

Bidder shall read all attachments and instructions carefully. Failure to completely become familiar with all attachments and notes will not be deemed just cause for claims or errors.

Any EXCEPTIONS to specifications, individual data sheets, drawings, terms and conditions or any other documents forming part of this Notice Inviting Informal Bids must be clearly defined and set forth in Bidder's response on this form. To be considered for an award, the Bidder must certify to either A or B below and explain exceptions, if any, on this form (and attachments, if needed).

A. This bid is in exact accordance with the specifications, drawings, terms and conditions and other requirements of this Invitation to Bid with NO EXCEPTIONS."

*** OR ***

B. "This bid is in exact accordance with the specifications, drawings terms and conditions and other requirements of this Notice Inviting Informal Bids with the EXCEPTIONS listed below:" (List the number of the specification excepted and in detail explain the exception. Add additional pages if necessary.)

Paragraph/Specification Section and details of exception:

1. _____
2. _____
3. _____

Bidder's Signature

Bidder's Trade Name (Company, Individual, etc.)

Date Signed

THIS PAGE INTENTIONALLY LEFT BLANK

HAZARDOUS AND TOXIC SUBSTANCES DISCLOSURE REQUIREMENTS

The Occupational Safety and Health Act (OSHA) of 1970, and OSHA regulation 29 CFR 1910.1200 contain hazardous and toxic substances reporting requirements. CONTRACTOR shall be required to provide the following documents, as applicable, to DISTRICT at the time of the purchase order award, if possible, but not later than ten (30) days thereafter. A copy of the Material Safety Data Sheet, Form OSHA-20 or equivalent, must accompany each shipment of hazardous or toxic substances to the DISTRICT. The following documents may be required for more than one item within the purchase order.

Material Safety Data Sheet, Form OSHA-20

The Material Safety Data Sheet, Form OSHA-20 or equivalent, is required for each material containing a chemical substance which: (i) is regulated by any Federal law or rule, (ii) is listed in the latest edition of the National Institute for Occupational Safety and Health Registry of Toxic Effects of Chemical Substances, (iii) testing has yielded positive evidence of an acute or chronic health hazard, or (iv) has a Material Safety Data Sheet available to the CONTRACTOR indicating that the material may pose a hazard to human health.

CONTRACTOR may alternatively submit a disclaimer statement set forth below:

HAZARDOUS AND TOXIC SUBSTANCES DISCLAIMER

The CONTRACTOR hereby swears or affirms that the material furnished on this purchase order does not, to its best knowledge, contain any toxic substances or harmful physical agents as defined under 29 CFR 1910-1200. In the event CONTRACTOR discovers that such hazardous and toxic substances or agents are to be supplied, an appropriate Material Safety Data Sheet, Form OSHA-20 or equivalent, shall be immediately supplied to the DISTRICT.

Bidder's Signature

Date Signed

Bidder's Trade Name (Company, Individual, etc.)

Non-compliance

CONTRACTOR assumes all responsibility for its failure to supply DISTRICT a completed Material Safety Data Sheet, Form OSHA-20 or equivalent, or a CONTRACTOR Disclaimer Statement, as applicable.

Change Orders

Change orders which increase or decrease quantities or cancel items do not require the CONTRACTOR to submit additional Material Safety Sheets, Form OSHA-20 or equivalent or Disclaimer Statements. However, CONTRACTOR shall submit a new Material Safety Data Sheet, Form OSHA-20 or equivalent, or a new Disclaimer Statement for all items which are revised or added by a change order within ten (10) days after receipt of the change order unless waived in writing by the DISTRICT.

THIS PAGE INTENTIONALLY LEFT BLANK

BIDDER’S SIGNATURE PAGE

By my signature on this proposal I certify, under penalty of perjury under the laws of the State of California, that the information submitted with this proposal for the CENTER PIVOT NO. 3 REPLACEMENT, which information includes, but is not limited to, the Bidder’s Check List, Proposal and Bid Schedule, Acknowledgement of Bid Addenda, Bid Bond, Non-Collusion Affidavit, Statement of Compliance, and Hazardous and Toxic Substances Disclosure Requirements are accurate, true and correct, and are submitted in accordance with the requirements of the Contract Documents issued by the Las Gallinas Valley Sanitary District concerning the CENTER PIVOT NO. 3 REPLACEMENT, and applicable law. By my signature on this proposal I further certify that I am legally authorized to bind the bidder in accordance with the requirements of the Contract Documents.

Date: _____

Typed or Printed Name: _____

Signature: _____

Bidder: _____

Bidder Business Address (Street, City, State and Zip Code)

Bidder Business Phone No.: _____

Bidder Business Fax No.: _____

Bidder Email Address: _____

THIS PAGE INTENTIONALLY LEFT BLANK

CONTRACTOR AGREEMENT (THE ATTACHED FORM MUST BE SIGNED BY AN AUTHORIZED OFFICIAL AFTER THE AWARD OF A CONTRACT BY THE DISTRICT.)

THIS PAGE LEFT INTENTIONALLY BLANK

CONTRACTOR AGREEMENT

PROJECT NAME

(JOB NO. _____)

THIS AGREEMENT made this _____ day of _____ 20____, by and between the **LAS GALLINAS VALLEY SANITARY DISTRICT** (hereinafter referred to as "DISTRICT"), and _____, whose address is _____, (hereinafter referred to as "CONTRACTOR").

WITNESSETH:

IN CONSIDERATION of the mutual covenants and conditions herein contained, the parties do hereby agree as follows:

1. **General**

DISTRICT engages CONTRACTOR to furnish the services hereinafter mentioned upon the covenants and conditions of this Agreement, at the compensation herein stipulated, and CONTRACTOR accepts said engagement upon said terms.

2. **Duties of Contractor: Services to be Performed by Contractor**

CONTRACTOR shall perform such duties and services as are listed on Exhibit A attached hereto, signed by the parties hereby referred to and made part hereof by reference. Said services shall be completed according to the time schedule contained in Exhibit A.

3. **Services or Materials to be Performed or Furnished by District**

DISTRICT shall perform such services or furnish such materials to CONTRACTOR in connection with this Agreement as are set forth on Exhibit B. If there are no entries on said Exhibit B, DISTRICT shall not be required to provide any services or furnish any materials to CONTRACTOR. Unless otherwise provided on Exhibit B, all said services and materials to be furnished by DISTRICT will be without cost to CONTRACTOR.

4. **Payment by District: Time and Manner of Payment**

DISTRICT shall pay CONTRACTOR, for all services to be rendered and all materials to be furnished under this Agreement, the amount specifically set forth and in the manner specifically set forth on Exhibit A. CONTRACTOR agrees to accept said sum as full compensation for all services under this Agreement.

5. **Additional Work**

CONTRACTOR shall only be entitled to extra compensation for services or materials not otherwise required under this Agreement, if DISTRICT shall first have identified the services or

materials as extra and requested such extra services or materials in writing; but, in no event shall DISTRICT be liable for payment unless the amount of such extra compensation shall first have been agreed to in writing by DISTRICT.

6. Professional Skill

CONTRACTOR represents that CONTRACTOR is skilled and licensed by the State of California in the professional calling necessary to perform the work agreed to be done under this Agreement. DISTRICT relies upon the skill of CONTRACTOR to do and perform its work in a skillful manner, and CONTRACTOR agrees to thus perform its work, and the DISTRICT'S acceptance of CONTRACTOR'S work shall not operate as a release of CONTRACTOR from this Agreement. For purposes of this Agreement, "skillful manner" shall mean the prevailing industry standard during the term of this Agreement.

7. Equal Employment Opportunity

CONTRACTOR shall not discriminate against any employee or applicant for employment because of race, religion, creed, national origin, amnesty, physical handicap, medical condition, marital status or sex of such person except as provided in Section 12940 of the Government Code.

8. Compliance with Laws

CONTRACTOR shall comply with all applicable federal, state, and local laws, statutes, ordinances, rules and regulations and the orders and decrees of any courts or administrative bodies or tribunals in any manner affecting the performance of the Agreement. Compliance with this section shall include, but not limited to, the following:

- a. CONTRACTOR shall set forth:
 - 1. The name and the location of the place of business of each subcontractor who will perform work or labor or render service to the CONTRACTOR pursuant to Public Contract Code § 4104.
 - 2. The name and location of the place of each subcontractor certified as a minority, women, or disabled veteran business enterprise who will perform work or labor or render service to the CONTRACTOR to fulfill minority, women, and disabled veteran business enterprise goals pursuant to Public Contract Code § 2001.
- b. CONTRACTOR and its subcontractors shall pay "prevailing wages" in compliance with Labor Code § 1773.

9. Independent Contractor

CONTRACTOR is acting as an independent contractor in furnishing the services or materials and performing the work required by this Agreement and is not an agent, servant or employee of DISTRICT.

10. Indemnity

CONTRACTOR agrees to indemnify, save harmless and defend DISTRICT, its officers and employees from all costs, expenses, claims, liabilities or damages to persons or property arising out of or in any way connected with the performance of the CONTRACTOR'S work by the CONTRACTOR, its officers, employees, agents, contractors, subcontractors or any officer, agent or employee thereof. However, this indemnity will not extend to any loss, damage, or expense arising out of the active negligence of the DISTRICT or the DISTRICT'S.

11. Insurance: Public Liability, Worker's Compensation

CONTRACTOR shall maintain for the duration of the contract insurance against claims for injuries to persons or damages to property which may arise from or in connection with the performance of the work hereunder by the CONTRACTOR, and their agents, representatives, or employees.

See Exhibit C for DISTRICT Insurance Requirements

12. Work Safety

CONTRACTOR shall provide adequate employee supervision and comply with all safety regulations while performing activities in connection with this Agreement. CONTRACTOR acknowledges that he has been provided and understands the DISTRICT'S safe work requirements listed as Exhibit D.

13. Notices

Unless otherwise provided herein, all notices required hereunder shall be given by certified mail, postage prepaid and addressed to the party at the address indicated in the opening paragraph of this Agreement provided however, that in lieu thereof, notice may be given by personal delivery to the party at said address.

14. Title to Documents

All original calculations, photographs, maps, drawings, plans, design notes and other material or documents developed or used in connection with the performance of this Agreement shall be the property of DISTRICT provided, however, that CONTRACTOR may provide DISTRICT with legible photostatic copies thereof in lieu of the originals upon approval by DISTRICT representative. Any plans and specifications shall bear the name of the CONTRACTOR.

15. Assignment

Neither party shall assign or sublet any portion of this Agreement without the written consent of the other party in writing.

16. Termination

Without limitation to such rights or remedies as DISTRICT shall otherwise have by law, DISTRICT shall also have the right to terminate this Agreement for any reason upon seven (7) days' written notice to CONTRACTOR. This Agreement may also be terminated by either party upon seven (7) days' written notice should the other party fail substantially to perform in accordance with this Agreement through no fault of the other or if the project is stopped by conditions beyond the control of the DISTRICT.

17. Venue

Venue for any action of any nature regarding this Agreement shall be in Superior Court in the County of Marin.

18. Miscellaneous

Failure on the part of either party to enforce any provisions of this Agreement shall not be construed as a waiver or the right to compel enforcement of such provisions or any other provision.

19. Additional Provisions, Exhibits

Additional provisions of this Agreement are set forth on Exhibit F. All Exhibits shall be attached to, signed by the parties, and are hereby referred to and made a part hereof by reference.

20. Attorneys' Fees

If any party to this contract resorts to an action or arbitration to enforce or interpret any provision of this contract, the prevailing party shall be entitled to recover reasonable attorneys' fees in addition to any other relief to which that party may be entitled.

21. Severability

If a court of competent jurisdiction finds or rules that any provision of this Agreement is invalid, void, or unenforceable, the provisions of this Agreement not so adjudged shall remain in full force and effect. The invalidity in whole or in part of any provision of this Agreement shall not void or affect the validity of any other provision of this Agreement.

22. Entire Agreement: Amendment

This contract supersedes any and all other agreements, whether oral or in writing, between the parties with respect to the subject of this contract. Except as to those documents specifically incorporated by reference into this contract, this contract contains all of the covenants and agreements between the parties with respect to the subject of this contract, and each party acknowledges that no representations, inducements, promises, or agreements have been made by or on behalf of any party except the covenants and agreements embodied in this

contract. No agreement, statement, or promise not contained in this contract shall be valid or binding on the parties with respect to the subject of this contract. No modifications hereof shall be effective unless such modification is in writing signed by all parties to this Agreement.

IN WITNESS WHEREOF, the parties have hereunto set their hands the day and year first above written.

LAS GALLINAS VALLEY SANITARY DISTRICT

By _____
General Manager Date

CONTRACTOR COMPANY NAME

By _____
Signature Date

Print Name & Title

NOTE: The following exhibits are hereby incorporated into this Agreement by this reference:

- Exhibit A: Scope of Work
- Exhibit B: Services or Materials to be Performed or Furnished by District
- Exhibit C: General Conditions
- Exhibit D: District Safe Work Requirements
- Exhibit E: Contractor's License & Workers' Compensation Insurance Info
- Exhibit F: Performance Bond
Payment/Labor and Materials Bond
2-Year Maintenance Bond

Exhibit A
Scope of Work

Exhibit B

Services or Materials to be Performed or Furnished by District

Exhibit C
General Conditions

GENERAL CONDITIONS

1. DEFINITIONS:

The following terms as used in any agreement of which these General Conditions are a part are defined as follows:

- 1.1 Agreement: The agreement between the District and Contractor concerning the Project, as evidenced by and comprised of the Contract Documents.
- 1.2 Architect or Engineer: The person or persons so specified on the title sheet of the Technical Specifications and/or Drawings.
- 1.3 Bid Package: All of the documents listed as comprising the entire Bid Package as specified in the Notice Inviting Informal Bids and representing the full set of documents made available to bidders on the Project.
- 1.4 District: Las Gallinas Valley Sanitary District
- 1.5 Documents/Contract Documents: All those documents listed in the Project agreement as comprising the entire agreement between the District and the Contractor.
- 1.6 Construction Manager – The person, firm, designated in writing by the District to act as its representative at the construction site and to perform construction observation services and administrative functions relating to this Contract. All contact by the Contractor with the District shall be through the Construction Manager.
- 1.7 Contractor: The successful bidder for the Project and party to the Project agreement with the District as specified in the Project agreement.
- 1.8 Days: Unless otherwise specified in the Contract Documents, days mean working days. Where necessary for clarity, calendar days and working days are appropriately specified as such in the Contract Documents.
- 1.9 Project: The project as described in the Notice Inviting Informal Bids and the Technical Specifications and Drawings.
- 1.10 District Engineer: The District's authorized representative for administration and overall management of the Project agreement and Work. The District Engineer is the official point of contact between the District, the Architect and/or Engineer, and the Contractor.
- 1.11 Owner: Las Gallinas Valley Sanitary District
- 1.12 Drawings: The primarily graphic detailed requirements concerning the Project issued prior to bid opening, Equal Product Proposals accepted by the District and signed by authorized District representatives prior to bid opening, and change orders and other

amendment to the Drawings signed by authorized representatives of the District and the Contractor in accordance with the requirements of the Contract Documents.

- 1.13 Project Inspector: The party or parties charged by the District with inspecting the Work for compliance with the requirements of the Contract Documents and applicable laws and regulations. The Project Inspector acts under the direction of the District and shall coordinate with the District Engineer and Architect as directed by the District in accordance with the Contract Documents.
- 1.14 Subcontractor: A person, firm or corporation that is obligated as a party to a contract with the Contractor to perform part of the Project work. For purposes of these General Conditions Subcontractors include, but are not limited to, those that are obligated as parties to a contract with the Contractor to specially fabricate and install a portion of the Project Work according to the Technical Specifications and/or Drawings.
- 1.15 Technical Specifications: The detailed Project requirements contained in the Bid Package and any addenda to the Technical Specifications signed by authorized District representatives and issued prior to bid opening, Equal Product Proposals accepted by the District and signed by authorized District representatives prior to bid opening, and change orders and other amendments to the Technical Specifications signed by authorized representatives of the District and the Contractor in accordance with the requirements of the Contract Documents.
- 1.16 Work: The furnishing of all equipment, tools, apparatus, facilities, material, labor and skill necessary to perform and complete in a good and workmanlike manner the Project as shown in the Technical Specifications and Drawings in accordance with the Contract Documents and applicable law.
- 1.16 Written Notice: Will be deemed to have been duly served for purposes of these General Conditions and any agreement of which they are a part if delivered in person to the individual or to a member of the firm or to any office of the corporation for whom the notice is intended, or if sent by registered or certified mail to the last known business address known to the party giving notice. Unless otherwise specified in the Contract Documents, the last known address of the Contractor shall be that listed in the Contractor's Pre-Qualification Application.

2. SCOPE OF WORK

- 2.1 Documents Furnished by District. The District will furnish to the Contractor, free of charge, five (5) sets of half-size prints of the Drawings and Technical Specifications for execution of the Work. Throughout the performance of the Work the Contractor must keep one copy of the Drawings and Technical Specifications in good order and available for review by the District Engineer, the Engineer, the Architect, and any other District contractors or representatives.
- 2.2 Ownership of Documents Furnished by District. All documents furnished by the District, including, but not limited to, the Technical Specifications, Drawings, and any copies, are the property of the District. Documents furnished by the District may not be used on any other work. All documents furnished by the District must be returned to District upon completion of the Work.

2.3 Technical Specifications and Drawings.

- 2.3.1 The Technical Specifications and Drawings are complementary and intended to mutually describe the Work necessary to complete the Project in accordance with the Contract Documents.
- 2.3.2 In general, the Drawings indicate dimensions, position and kind of construction, and the Technical Specifications indicate qualities and methods. Any Work indicated on the Drawings and not mentioned in the Technical Specifications or vice versa must be furnished as though fully set forth in both. Work that is not particularly detailed, marked or specified shall be the same as similar Work that is detailed, marked or specified. The Contractor must furnish items necessary for the operation of equipment depicted in the Drawings or specified in the Technical Specifications that are suitable to allow such equipment to function properly at no extra charge.
- 2.3.3 The Contractor must notify the District Engineer and the Architect as soon as possible of any apparent errors or inconsistencies, including, but not limited to, typographical or notational errors in the Drawings, Technical Specifications, and/or in work done by others affecting the Work. The District Engineer will issue instructions concerning any such apparent errors or inconsistencies. If the Contractor proceeds with Work impacted by apparent errors or inconsistencies without instructions from the District Engineer, the Contractor shall do so at its sole risk and shall have all of the obligations and the District shall have all of the rights and remedies specified in Section 11 concerning any resulting damage or defect.
- 2.3.4 The General Conditions apply with equal force to all of the Work, including extra work authorized by the District Engineer in accordance with the Contract Documents. The Contractor must submit any required shop diagrams and/or drawings by the times and in the quantities indicated in the Technical Specifications. Any such shop diagrams and/or drawings must show completely the Work to be done, expanding on the Drawings concerning details not previously shown, field conditions and the condition of the Work. Architect or Engineer review of such shop diagrams and/or drawings will concern conformance with the requirements of the Contract Documents only. The Architect or Engineer assumes no responsibility for the correctness or accuracy of the dimensions or any other contents of any shop diagrams and/or drawings submitted by the Contractor. The Contractor must check all dimensions at the Work site. Shop diagrams and/or drawings must be clearly marked with the name of the Project and the name of the Contractor, subcontractor or supplier making the submittal, and must be stamped and signed by the Contractor and submitted under a signed transmittal letter from the Contractor certifying that all dimensions have been checked at the Work site. These requirements are mandatory. The Architect or Engineer will not review shop diagrams and/or drawings that do not satisfy these requirements. The Contractor will be responsible for any and all discrepancies between dimensions of the actual Project site and/or Work and those shown on shop diagram and/or drawings submitted by the Contractor, and for any other errors contained in or resulting from such shop diagrams and/or drawings, including, but not limited to, errors in

material and/or equipment quantities and any resulting errors, delays or additional cost in the performance of the Work. The Contractor will have all of the obligations and the District will have all of the rights and remedies that are specified in Section 11 concerning any discrepancies or errors in shop diagrams and/or drawings submitted by the Contractor, and concerning any resulting errors, delays or additional costs in the performance of the Work.

3. CONTROL OF WORK AND MATERIAL

- 3.1 District Engineer's Status. The District Engineer will administer the Project in accordance with the Contract Documents. After execution of the agreement and issuance of the Notice to Proceed, all correspondence and/or instructions concerning the Project between the Contractor and/or District shall be forwarded through the District Engineer. Except as otherwise provided in the Contract Documents, the District Engineer will not be responsible for and will not have control or charge of construction means, methods, techniques, or procedures or for safety precautions in connection with the Work. The District Engineer, however, will have authority to reject materials and/or workmanship that do not conform to the requirements of the Contract Documents. The District Engineer will also have the authority to require inspection or testing of the Work.
- 3.2 Architect or Engineer's Status. The Architect or Engineer will advise the District Engineer concerning decisions on all claims of the Contractor and all other matters relating to the execution and progress of the Work or the interpretation of the Contract Documents. The Architect or Engineer will also advise the Construction Manger concerning Work that does not conform to the Contract Documents. Whenever, in the Architect's or Engineer's opinion, it is necessary or advisable in accordance with the Contract Documents, the Architect or Engineer may recommend to the District Engineer inspection or testing of the Work, whether or not such Work is then fabricated, installed or completed.
- 3.3 Inspection and Testing of Work and Material.
 - 3.3.1 The District, the District Engineer, the Architect or Engineer and their representatives will have access to the Work at all times wherever it is in preparation or progress. The Contractor must provide proper facilities for such access and for inspection.
 - 3.3.2 The Contractor must inspect all materials as delivered and promptly return all defective materials without waiting for their rejection by the District Engineer or Architect or Engineer.
 - 3.3.3 If the District Engineer, the Technical Specifications, or any laws, ordinances, or any public authority require any Work to be tested or approved, the Contractor must give the District Engineer timely notice of the Contractor's readiness for inspection. Inspections will be promptly made, and where practicable, at the source of supply. Any work subject to such testing that is covered up without timely notice to the District Engineer or without the approval or consent of the District Engineer must, if required by the District Engineer, be uncovered for examination at the Contractor's expense. The Contractor will have all of the obligations and the District will have all of the rights and remedies that are

specified in Section 11 concerning any work subject to testing that is covered up without timely notice to the District Engineer and that is not uncovered for examination at the Contractor's Expense if required by the District Engineer.

- 3.3.4 Tests of materials or qualification tests required by the Contract Documents must be made in accordance with the Technical Specifications and the requirements of the California Building Standards Code as adopted by the District and other applicable law. Copies of all testing reports shall be distributed as required in the Technical Specifications.
- 3.3.5 The District or its representatives may order re-examination of questioned Work. If ordered to do so, the Contractor must uncover such Work. If such Work is found to be according to the Contract Documents, the District shall pay the cost of uncovering and restoring the Work, unless such Work was subject to testing and covered up without timely notice to or approval of the District Engineer. If re-examined Work is found not in accordance with the Contract Documents, the Contractor must pay the cost of uncovering and restoring the Work. The Contractor will have all of the obligations and the District will have all of the rights and remedies that are specified in Section 11 concerning any re-examined Work not in accordance with the Contract Documents that the Contractor fails to uncover and restore at the Contractor's expense.
- 3.3.6 The Contractor must replace or correct without charge any material or workmanship found not to conform to the requirements of the Contract Documents, unless the District consents to accept such material or workmanship with an appropriate adjustment in the Contract Price. The Contractor must promptly segregate and remove non-conforming material from the Work site. The Contractor will have all of the obligations and the District will have all of the rights and remedies that are specified in Section 11 concerning any failure by the Contractor to replace or correct without charge any material or workmanship that does not conform to the requirements of the Contract Documents and that the District has not consented to accept.

3.4 Samples Furnished by the Contractor. The Contractor must furnish all samples for approval as directed in sufficient time to permit the Architect or Engineer to examine, approve and select samples before they are required by the progress of the Work. Portions of the Work for which samples are required and for which the Architect or Engineer has selected samples must be in accordance with such approved samples. Samples must be sent prepaid to the office of the District Engineer or to such place as the District Engineer may direct.

3.5 Materials and Substitutions.

- 3.5.1 Materials used for the Work must be new and of the quality specified. When not particularly specified, materials must be the best of their class or kind. The Contractor must, if required, submit satisfactory evidence as to the kind and quality of materials.
- 3.5.2 If the Contractor submitted complete information to the District Engineer for products proposed as equals in accordance with the Bid Package, and the District approved such products proposed as equals in writing, the Contractor may either furnish such products approved as equals, or furnish the products

listed by manufacturer name, brand or model number in the Technical Specifications or Drawings. The District retains the right, in its sole discretion, to accept or reject any other proposed substitution. To be considered, proposals concerning products proposed as equals must include sufficient information to permit the District to determine whether the products proposed as equals will satisfy the same performance requirements as products listed by manufacturer's name, brand or model number. Such performance requirements may include, but are not limited to, size, strength, function, appearance, ease of maintenance and repair, and useful life requirements. If the District does not accept a proposed substitution, the Contractor must furnish the product specified in the Technical Specifications or Drawings for the Contract Price, regardless of whether the product is specified by manufacturer's name, brand or model number, or otherwise.

3.5.3. During the performance of the Work, all materials must be neatly stacked, properly protected from the weather and other adverse impacts, and placed so as to avoid interference with efficient progress of the Work, with other activities of the District, or with the use of existing District facilities by the public. All materials must be delivered so as to ensure efficient and uninterrupted progress of the Work. Materials must be stored so as to cause no obstruction and so as to prevent overloading of any portion of the Work. The Contractor will be responsible for damage or loss of materials delivered to and/or stored at the Work site due to weather or other causes. The Contractor must promptly remove from the Work site all materials rejected by the District or its representatives as failing to conform to the requirements of the Contract Documents, whether such non-conforming materials have been incorporated in the Work or not. If the District or its representatives so direct, the Contractor must promptly replace and re-execute Work performed by the Contractor and order the replacement and re-execution of Work performed by subcontractors using non-conforming materials with materials that satisfy the requirements of the Contract Documents without expense to the District. The Contractor will bear the expense of making good all Work destroyed or damaged by such removal. The Contractor will have all of the obligations and the District will have all of the rights and remedies that are specified in Section 11 concerning any failure by the Contractor to replace or re-execute Work using non-conforming materials, and/or to make good all work destroyed or damaged by such removal and/or execution.

3.6 Audits and Examination of Records. The District may examine and audit at no additional cost to the District all books, estimates, records, contracts, documents, bid documents, bid cost data, subcontract job cost reports and other Project related data of the Contractor, subcontractors engaged in performance of the Work, and suppliers providing supplies, equipment and other materials required for the Work, including computations and projections related to bidding, negotiating, pricing or performing the Work or contract modifications and other materials concerning the Work, including, but not limited to, Contractor daily logs, in order to evaluate the accuracy, completeness, and currency of cost, pricing, scheduling and any other project related data. The Contractor will make available all such Project related data at all reasonable times for examination, audit, or reproduction at the Contractor's business office at or near the Work site, and at any other location where such Project related data may be kept until three years after final payment under the Agreement. Pursuant to California

Government Code Section 8546.7, if the amount of public funds to be expended is in excess of \$10,000, this Agreement shall be subject to the examination and audit of the State Auditor, at the request of the District, or as part of any audit of the District, for a period of three (3) years after final payment under the Agreement.

- 3.7 Advertising. No advertising signs of any kind may be displayed on the Work site, or on fences, offices or elsewhere adjacent to the Work site.
- 3.8 Project Schedule (**As Needed**). Within seven (7) calendar days of the Notice to Proceed, the Contractor shall submit a schedule showing each task of Work, the sequence of each task, the number of days required to complete each task, and the critical path controlling the completion of the entire Work. The schedule shall allow for the completion of the entire Work within the Time for Completion.
- 3.8.1 District Review of Schedule. The District may review the Contractor's submitted schedule and may note any exceptions. The Contractor shall correct any exceptions noted by the District within five (5) working days of being notified of the exceptions.
- 3.8.2 Update of Schedule. After submission of a schedule to which the District has taken no exceptions, the Contractor shall submit an updated schedule on a biweekly basis until completion of the Work. The updated schedule shall show the progress of Work as of the date specified in the updated schedule.
- 3.8.3 Float. The schedule shall show early and late completion dates for each task. The number of working days between these dates shall be designated as "float". The Float shall be designated to the Project and shall be available to both the District and the Contractor as needed.
- 3.8.4 Failure to Submit Schedule. If the Contractor fails to submit the schedule within the time period specified in Section 3.8, or the updated schedule as specified in Section 3.8.2, or submit a schedule to which the District has taken uncorrected exceptions, **the District shall be entitled to withhold payment for the next application for payment submitted after the schedule or updated schedule becomes late.**
- 3.8.5 Responsibility for Schedule. The Contractor shall have sole and exclusive responsibility for creating the schedule and properly updating it. The District has no authority to approve the schedule. The District may note exceptions to any schedule submitted by the Contractor. However, it shall be the Contractor's sole responsibility to determine the proper method to address exceptions and the District's review of the schedule shall not serve to place any such obligation on the District.

4. CHANGES IN WORK

- 4.1 District Directed Change Orders. The District may at any time during the progress of the Work direct any amendments to the Work or any of the Contract Documents, including, but not limited to the Technical Specifications, or Drawings. Such amendments will in no way void the agreement, but will be applied to amend the Contract Price, if such amendments affect the Contract Price, the Project schedule, if

such amendments affect the Project schedule, or any other provision of the Contract Documents based on a fair and reasonable valuation of the amendment in accordance with this Section 4.

- 4.2 Writing Requirement. Change orders and other amendments to the Technical Specifications, the Drawings, or other Contract Documents may be made only by a writing executed by authorized representatives of the District and the Contractor.
- 4.3 Contractor Proposed Change Orders. Unless the District Engineer otherwise authorizes or the District and the Contractor otherwise agree, change order proposals submitted by the Contractor must be submitted to the District Engineer no later than the time of the proposed change.
- 4.4 All Change Orders. All change order proposals must be submitted on completed Change Order forms provided in the Contract Documents. All such change order proposals must itemize all cost impacts of the proposed change order and include a total price for that change order and the amended Contract Price that would become effective upon execution of the change order. All change order proposals must specify any change in the Project schedule, or in any project milestone including, but not limited to, the Time for Completion, under the change order. It is understood that change orders that do not specify a change in any milestone, including, but not limited to, the Time for Completion, may be accomplished by the Time for Completion then in effect.
- 4.5 Change Order Pricing. Change order pricing will be governed by the following:
 - 4.5.1 Unit prices specified in the Contract Documents will apply to cost impacts involving items for which the Contract Documents specify unit prices.
 - 4.5.2 Cost impacts involving items for which no unit prices are specified will be calculated by adding the itemized actual direct cost that would be added or reduced under the change order and an allowance for indirect costs in accordance with this Section. Itemization for direct costs for required labor must include the classifications of labor required, the total hours required for each classification, the hourly rate for each classification and other labor related costs such as liability and workers compensation insurance, social security, retirement and unemployment insurance. All other cost impacts for which no unit prices are specified must be itemized as appropriate, including the cost of tools, vehicles, phones and other equipment, and the cost of all required materials or supplies. Indirect costs added under a change order may not exceed an allowance of seven (7) percent of the total of combined Contractor and subcontractor direct costs added under the change order. Such allowance covers Contractor overhead and profit under the change order and includes the cost of insurance in addition to that required pursuant to Section 8.8, bond premiums, superintendent labor, clerical labor, home office expenses, worksite office expenses, and utility costs under the change order. Such costs may not be itemized as direct costs under a change order. Indirect costs deducted under a change order will be calculated in exactly the same way as indirect costs added under a change order, except indirect costs deducted under a change order may not exceed an allowance of seven and a half (7.5) percent of

the total of combined Contractor and subcontractor direct costs deducted under the change order.

- 4.6 Liability Under Unapproved Change Orders. The Contractor shall be solely responsible for any and all losses, costs, or liabilities of any kind incurred by the Contractor, any subcontractor engaged in the performance of the Work, any party supplying material or equipment for the Work or any third party that are incurred pursuant to Contractor-proposed change orders prior to issuance of an approved change order executed in accordance with this Section 4. The Contractor will have all of the obligations and the District will have all of the rights and remedies that are specified in Section 11 concerning any work or resulting losses, costs, or liabilities pursuant to a Contractor proposed change order before issuance of an approved change order executed in accordance with this Section 4.
- 1.7 Changes Subject to Contract Documents. Any changes in the Work and/or the Contract Documents pursuant to change orders and any other amendments issued in accordance with the Contract Documents, including this Section 4, will in all respects be subject to all provisions of the Contract Documents, including, but not limited to, the Technical Specifications and the Drawings, except as modified by such change orders or amendments.
- 4.8 Change Order Disputes.
- 4.8.1 Disputed District Directed Change Orders. If the Contractor disputes a District directed change order following a reasonable effort by the District and the Contractor to resolve the dispute including, at a minimum, a meeting between appropriate representatives of the Contractor and the District, the Contractor must commence performing the Work consistent with the disputed change order within five (5) working days of the last meeting between representatives of the Contractor and the District to resolve the dispute, or within the time specified in the disputed District directed change order, whichever is later. In performing Work consistent with a disputed District-directed change order pursuant to this provision the Contractor will have all of the Contractor's rights concerning claims pursuant to the Contract Documents and applicable law.
- 4.8.2 Disputed Contractor Proposed Change Orders. If the District disputes a Contractor proposed change order, the District and the Contractor will use reasonable efforts to resolve the dispute including, at a minimum, holding a meeting between appropriate representatives of the Contractor and the District. Regardless of and throughout any such efforts to resolve the dispute the Contractor must continue performing the Work irrespective of and unmodified by the disputed change order. In continuing to perform the Work, the Contractor will retain all of the Contractor's rights under contract or law pertaining to resolution of disputes and protests between contracting parties. Disputes between the District and the Contractor concerning any Contractor-proposed change order or other amendment do not excuse the Contractor's obligation to perform the Work in accordance with the Contract Documents excluding such Contractor-proposed change order or other amendment by the Time for Completion or waive any other Project milestone or other requirement of the Contract Documents.

5. TRENCHING AND UTILITIES

5.1 Excavation More Than Four Feet Deep. In accordance with California Public Contract Code Section 7104, if the Work involves excavation more than four feet deep the Contractor must promptly notify the District in writing before disturbing: any material that the Contractor believes may be hazardous waste, as defined in Section 25117 of the Health and Safety Code, that is required to be removed to a Class I, Class II or Class III disposal site in accordance with provisions of existing law; any subsurface or latent physical conditions at the Work site differing from those indicated; or any unknown physical conditions at the Work site of any unusual nature, different materially from those ordinarily encountered and generally recognized as inherent in work of the character provided for in the Contract Documents. The District will promptly investigate any such conditions for which notice is given. If the District finds that the conditions do materially differ, or involve hazardous waste, and would cause a decrease or increase in the cost or time of performance of the Work, the District will issue a change order pursuant to Section 4 of these General Conditions. If a dispute arises between the District and the Contractor concerning whether the conditions materially differ, or involve hazardous waste, or cause a decrease or increase in the cost or time of performance, the Contractor will not be excused from any completion date provided in the Contract Documents, but shall proceed with all Work to be performed. The Contractor will retain all rights under contract or law pertaining to resolution of disputes and protests between contracting parties.

5.2 Excavation of Five Feet or More. In accordance with California Labor Code Section 6705, contractors performing contracts exceeding \$25,000 in cost and involving excavation five or more feet deep must submit for the District's acceptance, prior to excavation, a detailed plan showing the design of shoring, bracing, sloping, or other provisions to be made for worker protection from the hazard of caving ground during excavation. If the plan varies from the shoring system standards, it must be prepared by a registered civil or structural engineer.

5.3 Existing Utilities.

5.3.1 General – The location of known existing utilities and pipelines are shown on the Plans in their approximate locations. However, nothing herein shall be deemed to require the District to indicate the presence of existing service laterals or appurtenances whenever the presence of such utilities on the site of the project can be inferred from the presence of other visible facilities, such as buildings, cleanouts, meter and junction boxes, on or adjacent to the site of the Project.

The District will assume the responsibility for the timely removal, relocation, or protection of existing main or trunk line utility facilities located on the Project site if such utilities are not identified by the District in the Contract Documents or which cannot reasonably be inferred from the presence of other visible facilities.

5.3.2 Utility Location – It shall be the Contractor's responsibility to determine the exact location and depth of all utilities, including service connections, which have been marked by the respective utility owners and which the Contractor believes may affect or be affected by the Contractor's operations. The Contractor shall not be entitled to additional compensation nor time extensions

for work necessary to avoid interferences nor for repair to damaged utilities if the Contractor does not expose all such existing utilities as required by this section.

The locating of utilities shall be in conformance with Government Code Section 4216 et seq. except for the District's utilities located on the District's property and not on public right-of-way.

A "High Priority Subsurface Installation" is defined in Section 4216 (e) as "high-pressure natural gas pipelines with normal operating pressures greater than 415kPA gauge (60psig) or greater than six inches nominal pipe diameter, petroleum pipelines, pressurized sewage pipelines, high-voltage electric supply lines, conductors, or cables that have a potential to ground of greater than or equal to 60kv, or hazardous materials pipelines that are potentially hazardous to workers or the public if damaged."

A "Subsurface Installation" is defined in Section 4216 (l) as "any underground pipeline, conduit, duct, wire, or other structure, except non-pressurized sewer lines, non-pressurized storm drains, or other non-pressurized drain lines."

Pursuant to Government Code Section 4216.2 the Contractor shall contact the appropriate regional notification center at least two (2) working days but not more than fourteen (14) calendar days before performing any excavation. The Contractor shall request that the utility owners conduct a utility survey and mark or otherwise indicate the location of their service. The Contractor shall furnish to the Construction Manager written documentation of its contact(s) with the regional notification center prior to commencing excavation at such locations.

After the utility survey is completed, the Contractor shall commence "potholing" or hand digging to determine the actual location of the pipe, duct, or conduit. The Construction Manager and District Engineer shall be given notice prior to commencing potholing operations. The Contractor shall uncover all piping and conduits, to a point one (1) foot below the pipe, where crossings, interferences, or connections are shown on the Drawings, prior to trenching or excavating for any pipe or structures, to determine actual elevations. New pipelines shall be laid to such grade as to clear all existing facilities, which are to remain in service for any period subsequent to the construction of the run of pipe involved.

The Contractor's attention is directed to the requirements of Government Code Section 4216.2 (a)(2) which provides: "When the excavation is proposed within 10 feet of a high priority subsurface installation, the operator of the high priority subsurface installation shall notify the excavator of the existence of the high priority subsurface installation prior to the legal excavation start date and time, as such date and time are authorized pursuant to paragraph (1) of subdivision (a) of 4216.2. The excavator and the operator or its representative shall conduct an onsite meeting at a mutually-agreed-on time to determine actions or activities required to verify the location of the high priority subsurface installation prior to start time." The Contractor shall notify the Construction Manager and District Engineer in advance of this meeting.

- 5.3.4. Utility Relocation and Repair – If interferences occur at locations other than those indicated in the Contract Documents with reasonable accuracy, the Contractor shall notify the Construction Manager and District Engineer in writing. The Construction Manager will supply a method for correcting said interferences in accordance with the responsibilities of this section and Government Code Section 4215.

Care shall be exercised by the Contractor to prevent damage to adjacent existing facilities and public or private works; where equipment will pass over these obstructions, suitable planking shall be placed. If high priority subsurface installations are damaged and the operator cannot be contacted, the Contractor shall call 911 emergency services.

The District will compensate the Contractor for the costs of locating and repairing damage not due to the failure of the Contractor to exercise reasonable care, and for removing or relocating such main or trunk line utility facilities not indicated in the Contract Documents with reasonable accuracy, and for the cost of equipment on the Project necessarily idled during such work. The payment for such costs will be made as provided in Section 4, Change Orders. The Contractor shall not be assessed liquidated damages for delay in completion of the Project, when such delay is caused by the failure of the District or utility company to provide for removal or relocation of such utility facilities.

The public utility, where they are the owner of the effected utility, shall have the sole discretion to perform repairs or relocation work or permit the Contractor to do such repairs or relocation work at a reasonable price. The right is reserved to the District and the owners of utilities or their authorized agents to enter upon the Work area for the purpose of making such changes as are necessary for the rearrangement of their facilities or for making necessary connections or repairs to their properties. The Contractor shall cooperate with forces engaged in such work and shall conduct its operations in such a manner as to avoid any unnecessary delay or hindrance to the work being performed by such forces and shall allow the respective utilities time to relocate their facility.

When the Contract Documents indicate that a utility is to be relocated, altered or constructed by others, the District will conduct all negotiations with the utility company and the work will be done at no cost to the Contractor, unless otherwise stipulated in the Agreement.

Temporary or permanent relocation or alteration of utilities desired by the Contractor for its own convenience shall be the Contractor's responsibility and it shall make arrangements and bear all costs for such work.

6. PROJECT FACILITIES

- 6.1 Work Site Offices. Any Work site office facilities used by the Contractor and/or its privities must conform to all applicable codes, ordinances and regulations. The cost of such Work site office facilities shall be paid from the included in the Contract Price.

6.2 District Rights of Access and Ownership. The District and its authorized representatives will at all reasonable times while such office facilities are located at the Work site (including, at a minimum, all times during which the Work is performed), have access to any such Work site office facilities used by the Contractor and/or its privities. With respect to the right of access of the District and its authorized representatives, neither the Contractor nor its privities shall have a reasonable expectation of privacy pursuant to the Fourth Amendment to the Unites States Constitution or other applicable law concerning such Work site office facilities used by the Contractor and/or its privities. Without exception, any and all Project related materials located at such Work site facilities will be deemed at all times to be District property subject to inspection and copying by the District and its authorized representatives at all reasonable times while such facilities are located at the Work site (including, at a minimum, all times during which the Work is performed). Any interference by the Contractor or its privities with the District's rights of access and/or ownership pursuant to this Section 6 will constitute a material breach of the Agreement subject to any and all remedies available pursuant to the Contract Documents and at law and equity.

7. PROSECUTION AND PROGRESS OF THE WORK

7.1 Liquidated Damages (**As Needed**). Time is of the essence in the Agreement. The District and the Contractor agree that it will be difficult and/or impossible to determine the actual damage which the District will sustain in the event of the Contractor's failure to fully perform the Work or to fully perform all of the Contractor's obligations that have accrued pursuant to the Agreement by the Time for Completion. Accordingly, the District and the Contractor agree in accordance with California Government Code Section 53069.85 that the Contractor will forfeit and pay to the District liquidated damages in the sum of \$1,000 per day for each and every calendar day completion of the Work and/or performance of all of the Contractor's obligations that have accrued pursuant to the Agreement is delayed beyond the Time for Completion. The District and the Contractor further agree in accordance with California Government Code Section 53069.85 that the liquidated damages sum specified in this provision is not manifestly unreasonable under the circumstances existing at the time the Agreement was made, and that the District may deduct liquidated damages sums in accordance with this provision from any payments due or that may become due the Contractor under the Agreement.

7.2 No Damage for Delay Beyond District and Contractor Control. The Contractor will not be held responsible for delays in performance of the Work caused by delay beyond the control of both District and Contractor, such as by strikes, lockouts, or labor disturbances that are not within the control of the contractor to resolve, lack or failure of transportation, or acts of other government entities. This provision will not apply where the delay would not have occurred but for a previous contractor caused delay in the prosecution of the Work. The District will not be liable to the Contractor, any subcontractor or other entity engaged in the performance of the Work, any supplier, or any other person or organization, or to any surety or employee or agent of any of them, for damages arising out of or resulting from (i) delays beyond the control of the District and the Contractor including but not limited to fires, floods, epidemics, abnormal weather conditions, earthquakes and acts of God or acts or neglect by utility owners or other contractors performing other work, or (ii) delays caused by the District,

its officials, officers, employees, agents, or volunteers, or delays caused by the District Engineer or the Architect or Engineer, which delays are reasonable under the circumstances involved and/or are within the contemplation of the District and the Contractor. An extension of the Time for Performance in an amount equal to the time loss due to such delay(s) will be the Contractor's sole and exclusive remedy for such delay(s).

- 7.3 No Damage for Contractor Caused Delay. Contractor shall not be entitled to additional compensation for extended field or home office overhead, field supervision, costs of capital, interest, escalation charges, acceleration costs or other impacts for any delays to the extent such delays are caused by the failure of the Contractor or any subcontractor or other entity engaged in performance of the Work to perform the Work in accordance with the Contract Documents. Contractor may be eligible for additional compensation in excess of the Contract Price for delays caused by the District and/or its privities.
- 7.4 No Damage for Other Delay. Contractor will not be entitled to damages for delay to the Work caused by the following, which the District and Contractor agree will be deemed for purposes of California Public Contract Code Section 7102 either not caused by the District, and/or within the contemplation of the District and the Contractor, and/or reasonable under the circumstances:
- 7.4.1 Exercise of the District's right to sequence the Work in a manner that would avoid disruption to the District and other contractors based on: the failure of the Contractor or any subcontractor or other entity engaged in the performance of the Work to perform the Work in accordance with the Contract Documents, enforcement by the District or any other governmental agency of competent jurisdiction of any government act or regulation, or enforcement by the District of any provisions of the Agreement.
- 7.4.2 Requests for clarification or information concerning the Contract Documents or proposed change orders or modifications to the Contract Documents, including extensive and/or numerous such requests for clarification or information or proposed change orders or modifications, provided such clarifications or information or proposed change orders or modifications are processed by the District or its representatives in a reasonable time in accordance with the Contract Documents.
- 7.5 Delays Caused by the District and/or Its Privities. Either the District or the Contractor may propose a change in the Time for Completion for delays that are purported to be caused by the District and/or its privities and that are not reasonable under the circumstances involved and/or that are not within the contemplation of the District and the Contractor. Such proposed changes in the Time for Completion will constitute change order proposals subject to Section 4. In accordance with Section 4, the District and the Contractor may agree upon pricing for the cost impacts, if any, resulting from such delays. If such pricing is in anticipation of cost impacts that may, but have not yet occurred, the District will be obligated to pay the Contractor for such anticipated impacts in accordance with the Agreement and any applicable, approved change orders only to the extent the Contractor actually incurs the anticipated cost impacts. Notwithstanding anything to the contrary in Section 4.5.2, the District and the Contractor may agree to a daily rate or cap or lump sum that will apply to the cost impacts, if any, resulting from delay purportedly caused by the District and/or its

privities subject to this provision. However, if such daily rate or cap or lump sum is in anticipation of cost impacts that have not yet occurred, the District will be obligated to pay such daily rate or cap or lump sum only to the extent the Contractor actually incurs such cost impacts.

7.5.1 Weather Delays. Extensions of the Time for Completion will not be allowed for weather conditions that are consistent with the following list of anticipated rain days based on historical weather data of the National Oceanographic and Atmospheric Administration of the U.S. Department of Commerce for the record station that is nearest or most applicable to the Work site. Extensions of the Time for Completion for delays due to adverse weather will be allowed only if the number of rain days exceeds those listed in the following table and the Contractor can verify to the District's reasonable satisfaction that such adverse weather caused actual delay in the timely completion of the Work. No extensions of the Time for Completion will be granted for rain days in addition to those listed in the following table that merely result in delays that do not or would not, themselves, result in failure to complete the Work by the Time for Completion. Anticipated weather delays, which may include rain, strong wind, or other types of inclement weather conditions, are as follows:

August through October:	4 days
November through April:	40 days
May through July	4 days

7.6 Delay Claims. Whenever the Contractor claims a delay for which the Time for Completion may be extended, the Contractor must request an extension of time within five (5) working days of the start of the delay. The request must be in writing and describe in detail the cause for the delay, and, if possible, the foreseeable extent of the delay.

7.7 Contractor Coordination of the Work.

7.7.1 The District reserves the right to do other work in connection with or in the vicinity of the Project by contract or otherwise, and Contractor shall at all times conduct the Work so as to impose no hardship on the District, others engaged in the Work or other contractors working at the Work site. The Contractor will adjust, correct and coordinate the Work with the work of others so that no delays result in the Work or other work at or near the Work site.

7.7.2 If any part of the Work depends for proper execution or results upon the work of the District or any other contractor, the Contractor will, before proceeding with such Work, promptly report to the District any apparent discrepancies or defects in such other Work. Failure of the Contractor to promptly report any apparent discrepancy or defect will be deemed an acceptance of the District's or other contractor's Work as fit and proper.

7.7.3 The Contractor will anticipate the relations of the various trades to the progress of the Work and will ensure that required anchorage or blocking is furnished and set at proper times. Anchorage and blocking necessary for each trade shall be part of the Work except where stated otherwise.

7.7.4 The Contractor will provide proper facilities at all times for access of the District, the District Engineer, Architect or Engineer, and other authorized District representatives to conveniently examine and inspect the Work.

7.8 Suspension of Work

7.8.1 If the Contractor fails to correct defective work, or fails to carry out the Work in accordance with the Contract Documents or any other applicable rules and regulations, the District, by a written order of the District 's representative or signed personally by an agent specifically so empowered by the District, in writing, may order the Contractor to stop the work, in its entirety or any portion thereof. In the event of a suspension of only a portion of the work, the Contractor is obligated to perform the portion of the work not suspended. The Suspension of Work shall remain in effect until the condition or cause for such order has been eliminated. The District's concurrence that the condition or cause has been eliminated will be provided to the Contractor in writing. This right of the District to stop and suspend the Work shall not give rise to any duty on the part of the District to exercise this right for the benefit of the Contractor or any other person or entity. All delays in the Work occasioned by such stoppage shall not relieve the Contractor of any duty to perform the Work or serve to extend the time for its completion. Any and all necessary corrective work done in order to comply with the Contract Documents shall be performed at no cost to the District.

7.8.2 In the event that a suspension of Work is ordered, as provided in this paragraph, the Contractor, at its expense, shall perform all work necessary to provide a safe, smooth, and unobstructed passageway through construction for use by public, pedestrian, and vehicular traffic, during the period of such use by suspension. Should the Contractor fail to perform the Work as specified, the District may perform such work and the cost thereof may be deducted from partial payments and/or final payment due the Contractor under the Contract.

7.8.3 The District shall also have authority to suspend the Work wholly or in part, for such period as the District may deem necessary, due to unsuitable weather, or to such other conditions as are considered unfavorable for the suitable prosecution of the Work. Such temporary suspension of the Work will be considered justification for time extensions to the Contract in an amount equal to the period of such suspension if such suspended work includes the current critical activity on the latest favorably reviewed progress schedule. The Contractor as directed by the District shall comply with the provisions in Section 7.8.2 above. Such additional work shall be compensated as provided for in Section 4, Changes in Work.

8. CONTRACTOR RESPONSIBILITIES

8.1. Eligibility. By executing the Agreement, the Contractor certifies that the Contractor is not ineligible to perform work on public works projects pursuant to California Labor Code Sections 1777.1 or 1777.7. In accordance with California Public Contract Code Section 6109(a), contractors who are ineligible to perform work on public works projects pursuant to California Labor Code Sections 1777.1 or 1777.7 may neither bid on, be awarded or perform the Work. The Contractor shall hold harmless and

indemnify the District from and against any and all damages, costs, and liability arising from or as a consequence of any violation of Public Contract Code Section 6109.

- 8.2 Supervision of the Work. The Contractor will be solely responsible for the performance of the Work, including portions of the Work to be performed by subcontractors. The Contractor is charged with ensuring that all orders or instructions from the District, District Engineer or Architect are disseminated to and followed by all subcontractors engaged in performance of the Work. The Contractor will supervise the Work using the Contractor's best skill and attention. At any time during the progress of the Work, the District, the District Engineer, or the Architect may require the Contractor and/or subcontractors engaged in performance of the Work to attend a project meeting and the Contractor will attend, and ensure the attendance of any subcontractors whose attendance is required by the District and/or advisable in light of the matters to be addressed at the meeting.
- 8.3 Contractor's Superintendent. The Contractor will keep on the Work, throughout its progress, a competent superintendent and any necessary assistants, all satisfactory to the District. The superintendent may not be changed without the consent of the District. The superintendent will represent the Contractor and all directions given by the District to the superintendent will bind the Contractor in accordance with the Agreement. Superintendent time included in Contractor's completed Bid Schedule and/or in approved change orders, if any, must be included in Contractor's approved overhead rate and may not be charged as a direct cost.
- 8.4 Competent Employees. The Contractor must at all times enforce strict discipline and good order among the Contractor's employees and may not employ on the Work any unfit person or anyone not skilled in the Work assigned, or anyone incompetent or unfit for the duties of that person. When the District determines that a Contractor employee does not satisfy the requirements of this provision, upon notice from the District, the Contractor must ensure that employee performs no further Work and is no longer present at the Work site. Any such Contractor employee may not again be employed on the Work without District approval.
- 8.5 Items Necessary for Proper Completion of the Work. Except as otherwise noted in the Contract Documents, the Contractor will provide and pay for all labor, materials, equipment, permits, fees, licenses, facilities and services necessary for the proper execution and timely completion of the Work in accordance with the Contract Documents.
- 8.6 Construction Reports. The Contractor must submit daily construction reports detailing the daily progress of the Work to the District Engineer on a weekly basis.
- 8.7 Subcontracting.
- 8.7.1 By executing the Agreement, the Contractor certifies that no subcontractor included on the list of proposed subcontractors submitted with the Contractor's bid is ineligible to perform work on public works projects pursuant to California Labor Code Sections 1777.1 or 1777.7. In accordance with California Public Contract Code Section 6109(a), subcontractors who are ineligible to perform work on public works projects pursuant to California Labor Code Sections 1777.1 or 1777.7 may neither bid on, be awarded or perform as a subcontractor

on the Work. In accordance with California Public Contract Code Section 6109(b), any contract on a public works project entered into between a contractor and a debarred subcontractor is void as a matter of law. The Contractor will ensure that no debarred subcontractor receives any public money for performing the Work, and any public money that may have been paid to a debarred subcontractor for the Work is returned to the District. The Contractor will be responsible for payment of wages to workers of a debarred subcontractor who has been allowed to perform the Work.

8.7.2 The Agreement and the performance of the Work are subject to the requirements of the Subletting and Subcontracting Fair Practices Act codified at California Public Contract Code Section 4100 and following. If the Contractor fails to specify a subcontractor or specifies more than one subcontractor for the same portion of the Work in excess of one-half of 1 percent of the Contractor's total bid, the Contractor agrees that the Contractor is fully qualified to perform that portion of the Work with the Contractor's own forces, and that the Contractor will perform that portion of the Work with the Contractor's own forces. If after award of the Agreement the Contractor subcontracts, except as provided for in California Public Contract Code Sections 4107 or 4109, any such portion of the Work, the Contractor will be subject to the penalties set forth in California Public Contract Code Sections 4110 and 4111, including cancellation of the Agreement, assessment of a penalty of up to 10 percent of the amount of the subcontract, and disciplinary action by the Contractors State License Board.

8.7.3. No contractual relationship exists between the District and any subcontractor engaged in performance of the Work.

8.7.4 Incorporation of Contract Documents. The Contractor must incorporate the Contract Documents in each contract with a subcontractor engaged in the performance of the Work. The Contractor shall be solely responsible for any delay or additional costs incurred as a result of its failure to provide adequate or accurate project information to a subcontractor that results in improper submittals and/or work, or time or other impacts is the sole responsibility of the Contractor. The Contractor will have all of the obligations and the District will have all of the remedies that are specified in Section 11.

8.7.5 Coordination of Subcontract Work: The Contractor is responsible for scheduling the Work of subcontractors so as to avoid delay or injury to either Work or materials.

8.8 Insurance.

8.8.1 All required insurance shall be provided in the form of "occurrence"-type policies underwritten by admitted insurers in the State of California with a current A.M. Best rating of no less than A: VII, unless otherwise acceptable to the District. All policies must be issued at the expense of the Contractor and must be maintained at the Contractor's expense throughout the performance of the Work. Coverage should be maintained for a minimum of five (5) years after contract completion.

- 8.8.2 The Contractor and any subcontractors engaged in performance of the Work must secure payment of workers compensation in accordance with California Labor Code Section 3700 and other applicable law. The Contractor must verify that all Subcontractors comply with this requirement.
- 8.8.3 Within seven (7) calendar days following Notice of Award the Contractor must submit to the District along with executed copies of all other documents specified in the Contract Check List certificates of insurance and endorsements evidencing that the Contractor has in effect and will maintain throughout the performance of the Work the following kinds and amounts of insurance:
- 8.8.3.1 Worker's Compensation Insurance. In accordance with the provisions of Article 5, Chapter 1, Part 7, Division 2 (commencing with Section 1860) and Chapter 4, Part 1, Division 4 (commencing with Section 3700) of the Labor Code of the State of California, the Contractor is required to secure the payment of compensation to its employees and for that purpose obtain and keep in effect adequate Workers' Compensation Insurance. If the Contractor, in the sole discretion of the District, satisfies the District of the responsibility and capacity under the applicable Workers' Compensation Laws, if any, to act as self-insurer, the Contractor may so act, and in such case, the insurance required by this paragraph need not be provided. The Contractor is advised of the provisions of Section 3700 of the Labor Code, which require every employer to be insured against liability for Workers' Compensation or to undertake self-insurance in accordance with the provisions of that code, and shall comply with such provisions and have Employers' Liability limits of **\$1,000,000** per accident and per employee, and in the aggregate for injury by disease, before commencing the performance of the work of this Contract. Before the Notice to Proceed with the Work under this Contract is issued, the Contractor shall submit written evidence that the Contractor has obtained for the period of the Contract Workers' Compensation and Employer's Liability Insurance as required for all persons whom it employs or may employ in carrying out the work under this Contract. Such evidence of coverage shall be accompanied by an endorsement from the insurer agreeing to waive all rights of subrogation against the District, its officers, officials, employees, agents and volunteers, the Design Consultants, the Construction Manager and their agents, consultants and employees which might arise by reason of any payment under the policy. This insurance shall be in accordance with the requirements of the most current and applicable State Workers' Compensation Insurance Laws.
- 8.8.3.2 Commercial General Liability and Automobile Liability Insurance - This insurance shall protect the Contractor from claims for bodily injury, personal injury and property damage which may arise because of the nature of the work or from operations under this Contract. The Commercial General Liability Insurance shall be maintained for five (5) years after final completion and shall provide coverage on an occurrence basis.

a. Additional Insureds - The Commercial General Liability and Automobile Policies of insurance shall include as additional insureds or be endorsed to contain the following provisions the "entities" listed below and each of their partners, officers, officials, employees, agents and volunteers are to be covered as insureds as respects: liability arising out of activities performed by or on behalf of the Contractor; products and completed operations of the Contractor; premises owned, occupied or used by the Contractor and or automobiles owned, leased, hired or borrowed by the Contractor. The coverage shall contain no special limitation on the scope of protection afforded to the "entities" and each of their partners, officers, officials, employees, agents and volunteers and coverage provided to such additional insured. This policy shall provide coverage to each of the said insureds with respect to said work. Said policy shall provide primary coverage to the full limit of liability stated in the declarations.

Las Gallinas Valley Sanitary District
300 Smith Ranch Road
San Rafael, CA 94903

Design Engineer: TBD
Construction Manager: TBD
District Consultants: TBD
Other Public Agencies Having Jurisdiction

b. (1) Amount of Coverage (General Contractor) - The bodily injury, personal injury and property damage liability of the Commercial General Liability insurance shall provide coverage in the following limits of liability: **\$3,000,000** on account of anyone occurrence for bodily injury and property damage, **\$3,000,000** personal and advertising injury limit with an annual general aggregate limit of not less than **\$3,000,000**, and **\$3,000,000** products and completed operations aggregate, combined single limit. The Automobile Liability insurance policy shall provide minimum limits of **\$3,000,000** per accident for bodily injury and property damage and **\$3,000,000** policy aggregate arising out of the ownership, maintenance, or use of any owned or non-owned vehicles.

(2) Amount of Coverage for Subcontractors - The bodily injury, personal injury and property damage liability of the Commercial General Liability insurance shall provide coverage in the following limits of liability: **\$1,000,000** on account of anyone occurrence for bodily injury and property damage **\$1,000,000** personal and advertising injury limit with an annual general aggregate limit of not less than **\$1,000,000**, and **\$1,000,000** products and completed operations aggregate, combined single limit. The Automobile Liability insurance policy shall provide minimum limits of **\$1,000,000** per accident and **\$1,000,000** policy aggregate arising out of the ownership, maintenance, or use of any owned or non-owned vehicles.

- c. Subcontractors - The bodily injury and property damage liability insurance shall not be deemed to require the Contractor to have its subcontractors named as insureds in the Contractor's policy, but the policy shall protect the Contractor from contingent liability which may arise from operations of its subcontractors.
- d. Included Coverage - The above Commercial General Liability insurance shall also include the following coverage:
 - Premises – Operations
 - Independent Contractors
 - Products - Completed Operations
 - Personal Injury - (False Arrest, Libel, Wrongful Eviction, etc.)
 - Advertising Injury
 - Broad Form Property Damage, Including, Completed Operations
 - Separation of Insureds/Cross-Liability Provision
 - Duty to Defend all Insureds
 - Deletion of any Limitation on Coverage for Bodily Injury or Property Damage Arising out of Subsidence or Soil or Earth Movement
 - Separate Aggregate - A provision that the annual general aggregate and the products and completed operations annual aggregate shall apply separately to each project for which Contractor provides services away from premises owned by or rented to Contractor.
 - XCU - (Explosion, Collapse, and Underground Damage) is applicable to operations performed by the Contractor or its subcontractors.
 - Blanket Contractual Liability

8.8.3.3 Commercial Umbrella Policy. The Commercial policy is to insure losses above General liability, Employers liability, Auto liability, and Contractor's Pollution Legal liability limits. The Contractor may use an umbrella policy to meet the limit requirements of Section 8.8.3.2.b(1). However, any such umbrella/excess policy must be approved by the District and maintain an A.M. Best Rating of no less than A:VII.

8.8.3.4 Builders Risk. (Not Required)

8.8.3.5 Contractor's Pollution Legal Liability. Coverage for liability because of third-party claims for bodily injury and/or property damage, including insurance for remediation costs stemming from pollution incidents resulting from the contractor's operations. The Contractor's Pollution Legal Liability insurance policy shall provide coverage with limits no less than \$1,000,000 per occurrence or claim, and \$2,000,000 policy aggregate.

8.8.4 For any claims related to this project, the Contractor's insurance coverage shall be primary and non-contributory insurance coverage as respects the District, its officers, officials, employees, and volunteers. Any insurance or self-insurance

maintained by the District, its officers, officials, employees, or volunteers shall be excess of the Contractor's insurance and shall not contribute with it. This requirement shall also apply to any Excess or Umbrella liability policies.

- 8.8.5 Any deductibles or self-insured retentions must be declared to and approved by the District.
- 8.8.6 Submit required insurance endorsement forms and other requirements.
- 8.8.7 For each insurance policy required under the Agreement except for the required workers compensation insurance policy, the Contractor must provide endorsements that add the District, its officers, officials, employees, and volunteers, as an additional insured. Such endorsements must: provide that the insurance required to be furnished by the Contractor will be primary as regards the District, its officers, officials, employees, and volunteers, and that the District's insurance will be excess of and not contribute to the insurance required to be furnished by the Contractor; that the District will receive 30-calendar day written notice of any reduction or cancellation of such insurance required to be furnished by the Contractor; and include a severability of interest clause acceptable to the District. Said endorsement shall be at least as broad as Insurance Services Office form number CG20 10 11 85 (Modified).
- 8.8.8 Contractor hereby grants to District a waiver of subrogation which any insurer may acquire against District, its officers, officials, employees, and volunteers, from Contractor by virtue of the payment of any loss. Contractor agrees to obtain any endorsement that may be necessary to affect this waiver of subrogation but this provision applies regardless of whether or not the District has received a waiver of subrogation endorsement from the insurer.
- 8.8.9 The Contractor shall not allow any subcontractor to commence work on its subcontract until all similar insurance required of the subcontractor, except Builder's Risk Insurance, has been obtained and verified by the Contractor and submitted to the Construction Manager for the District's review and records. Subcontractors shall furnish original certificates and required endorsements as verification of insurance coverage. The insurance liability limits specified in Sections 8.8.3.2.a(2), shall also apply for all subcontractors. The Contractor shall designate the required insurance liability limits for all other subcontractors.
- 8.8.10 Proof of Coverage - Before the Notice to Proceed with the Work under this Contract is issued, the Contractor shall furnish the District with certificate(s) evidencing issuance of all insurance mentioned herein, copies of the policy declaration or information page(s) and additional insured endorsements. The certificate(s) and endorsements for each insurance policy are to be signed by a person authorized by that insurer to bind coverage on its behalf. The endorsements are to be on forms or equivalent endorsement forms acceptable to the District. The certificate(s), policy declaration or information page(s), and endorsements are to be received and approved by the District before work commences. Except for the waiver of subrogation rights endorsements, no other endorsements are required for Workers Compensation or Builder's Risk Insurance. Such certificates of Insurance shall provide that the insurance policy shall be endorsed to state that coverage shall not be suspended, voided,

cancelled by either party, reduced in coverage or limits except after thirty (30) calendar days prior written notice by certified mail, return receipt requested, has been given to the District. Contractor shall also provide certificate(s) evidencing renewals of all insurance required herein, at least thirty (30) calendar days prior to the expiration date of any such insurance.

Any deductibles or self-insured retentions must be declared to and approved by the District. At the option of the District, either: the insurer shall reduce or eliminate such deductibles or self-insured retentions as respects the District, the Design Consultants and the Construction Manager and their officers, officials, employees, agents and volunteers; or the Contractor shall procure a bond guaranteeing payment of losses and related investigations, claim administration and defense expenses. In the event of the breach of any provision of this paragraph, or in the event of any notices received which indicates any required insurance coverage will be diminished or canceled, District, at its option, may, notwithstanding any other provisions of this Agreement to the contrary, immediately declare a material breach of this Agreement and suspend all further work pursuant to this Agreement.

8.8.11 Insurance During Guarantee Period

For any construction related work, including, but not limited to, maintenance, service, or repair work, performed by the Contractor or its subcontractors during the guarantee period, workers compensation, and commercial general liability insurance in the amounts and format required herein, shall remain in force and shall be maintained for five (5) years after final completion of the contract of work.

8.9 Indemnities.

8.9.1 The Contractor will take all responsibility for the Work, and will bear all losses and damages directly or indirectly resulting to the Contractor, any subcontractors engaged in performance of the Work, the District, its officials, officers, employees, agents, volunteers and consultants, and to third parties on account of the performance or character of the Work, unforeseen difficulties, accidents, or occurrences of other causes predicated on active or passive negligence of the Contractor or of any subcontractor engaged in performance of the Work. To the fullest extent permitted by law the Contractor will indemnify, defend and hold harmless the District, its officials, officers, employees, agents, volunteers and consultants from and against any or all loss, liability, expense, claims, costs (including costs of defense), suits, and damages of every kind, nature and description (including, but not limited to, penalties resulting from exposure to hazards in violation of the California Labor Code) directly or indirectly arising from the performance of the Work ("Claims").

8.9.2 The Contractor will indemnify, defend and hold harmless the District, the District's officials, officers, employees, volunteers, agents and the District Engineer and Architect for all liability on account of any patent rights, copyrights, trade names or other intellectual property rights that may apply to the Contractor's performance of the Work. The Contractor will pay all royalties or other charges as a result of intellectual property rights that may apply to methods, types of construction, processes, materials, or equipment used in the

performance of the Work, and will furnish written assurance satisfactory to the District that any such charges have been paid.

8.9.3 The Contractor assumes all liability for any accident or accidents resulting to any person or property as a result of inadequate protective devices for the prevention of accidents in connection with the performance of the Work. The Contractor will indemnify, defend, and hold harmless the District and its officials, officers, employees, agents, volunteers and consultants from such liability.

8.9.4 Approval of the Contractor's certificates of insurance and/or endorsements does not relieve the Contractor of liability under this Section 8.9. The Contractor will defend, with legal counsel reasonably acceptable to the District, any action or actions filed in connection with any Claims and will pay all related costs and expenses, including attorney's fees incurred. The Contractor will promptly pay any judgment rendered against the District, its officials, officers, employees, agents, volunteers or consultants for any Claims. In the event the District, its officials, officers, employees, agents, volunteers or consultants is made a party to any action or proceeding filed or prosecuted against Contractor for any Claims, Contractor agrees to pay the District, its officials, officers, employees, agents, volunteers and consultants any and all costs and expenses incurred in such action or proceeding, including but not limited to, reasonable attorneys' fees.

8.9.5 In accordance with California Civil Code Section 2782(a), nothing in the Agreement will be construed to indemnify the District for its sole negligence, willful misconduct, or for defects in design furnished by District. In accordance with California Civil Code Section 2782(b), nothing in the Agreement will be construed to impose on the Contractor or to relieve the District from liability for the District's active negligence. By execution of the Contract Documents the Contractor acknowledges and agrees that the Contractor has read and understands the insurance and other requirements of Agreement, and this Section 8.9, which is a material element of consideration.

8.10 Licenses/Permits. The Contractor must, without additional expense to the District, obtain all licenses, permits and other approvals required for the performance of the Work.

8.11 California Labor Code Requirements.

8.11.1 In accordance with California Labor Code Section 1810, eight (8) hours of labor in performance of the Work shall constitute a legal day's work under the Agreement.

8.11.2 In accordance with California Labor Code Section 1811, the time of service of any worker employed in performance of the Work is limited to eight hours during any one calendar day, and forty hours during any one calendar week, except in accordance with California Labor Code Section 1815, which provides that work in excess of eight hours during any one calendar day and forty hours during any one calendar week is permitted upon compensation for all hours worked in excess of eight hours during any one calendar day and forty hours during any one calendar week at not less than one-and-one-half times the basic

rate of pay. However, if the prevailing wage determination requires a higher rate of pay for overtime than is required under Section 1815, then the overtime rate must be paid, as specified in California Code of Regulation Title 8, Group 3, Section 16200(a)(3)(F).

- 8.11.3 In accordance with California Labor Code Section 1813, the Contractor and its subcontractors will forfeit as a penalty to the District \$25 for each worker employed in the performance of the Work for each calendar day during which the worker is required or permitted to work more than eight (8) hours in any one calendar day, or more than forty (40) hours in any one calendar week, in violation of the provisions of California Labor Code Section 1810 et seq.
- 8.11.4 In accordance with California Labor Code Section 1773.2, the District has determined the general prevailing wages in the locality in which the Work is to be performed for each craft or type of work needed to be as published by the State of California Department of Industrial Relations, Division of Labor Statistics and Research, a copy of which is on file in the office of the District Engineer and shall be made available on request. The Contractor and subcontractors engaged in the performance of the Work shall pay no less than these rates to all persons engaged in performance of the Work.
- 8.11.5 In accordance with California Labor Code Section 1775, the Contractor and any subcontractors engaged in performance of the Work must comply with Labor Code Section 1775 which establishes a penalty of up to \$200 per day for each worker engaged in the performance of the Work that the Contractor or any subcontractor pays less than the specified prevailing wage. The amount of such penalty shall be determined by the Labor Commissioner. The Contractor or subcontractor shall pay the difference between the prevailing wage rates and the amount paid to each worker for each calendar day or portion thereof for which each worker was paid less than the prevailing wage rate. If a subcontractor worker engaged in performance of the Work is not paid the general prevailing per diem wages by the subcontractor, the Contractor is not liable for any penalties therefore unless the Contractor had knowledge of that failure or unless the Contractor fails to comply with all of the following requirements:
 - 8.11.5.1 The contract executed between the Contractor and the subcontractor for the performance of part of the Work must include a copy of the provisions of California Labor Code Sections 1771, 1775, 1776, 1777.5, 1813, and 1815.
 - 8.11.5.2 The Contractor must monitor payment of the specified general prevailing rate of per diem wages by the subcontractor by periodic review of the subcontractor's certified payroll records.
 - 8.11.5.3 Upon becoming aware of a subcontractor's failure to pay the specified prevailing rate of wages, the Contractor must diligently take corrective action to halt or rectify the failure, including, but not limited to, retaining sufficient funds due the subcontractor for performance of the Work.

8.11.5.4 Prior to making final payment to the subcontractor, the Contractor must obtain an affidavit signed under penalty of perjury from the subcontractor that the subcontractor has paid the specified general prevailing rate of per diem wages employees engaged in the performance of the Work and any amounts due pursuant to California Labor Code Section 1813.

8.11.6 In accordance with California Labor Code Section 1776, the Contractor and each subcontractor engaged in performance of the Work, must keep accurate payroll records showing the name, address, social security number, work classification, straight time and overtime hours worked each day and week, and the actual per diem wages paid to each journeyman, apprentice, worker, or other employee employed in performance of the Work. Each payroll record must contain or be verified by a written declaration that it is made under penalty of perjury, stating that the information contained in the payroll record is true and correct and that the employer has complied with the requirements of Sections 1771, 1811, and 1815 for any work performed by the employer's employees on the public works project. The payroll records required pursuant to California Labor Code Section 1776 must be certified and must be available for inspection by the District and its authorized representatives, the Division of Labor Standards Enforcement, and the Division of Apprenticeship Standards of the Department of Industrial Relations and must otherwise be available for inspection in accordance with California Labor Code Section 1776.

8.11.7 In accordance with California Labor Code Section 1777.5, the Contractor, on behalf of the Contractor and any subcontractors engaged in performance of the Work, will be responsible for ensuring compliance with California Labor Code Section 1777.5 governing employment and payment of apprentices on public works contracts.

Apprentices - Prior to commencing the Work, Contractor shall comply with the provisions of Labor Code 1777.5, including but not limited to the submission of contract award information to an applicable apprenticeship program that can supply apprentices to the site of the Work. Such information shall include an estimate of journeyman hours to be performed under this Contract, the number of apprentices proposed to be employed, and the approximate dates the apprentices would be employed. A copy of this information shall be submitted to the District if requested by the District.

A determination by the Chief of the Division of Apprenticeship Standards that Contractor or its subcontractors have knowingly violated Labor Code 1777.5 shall forfeit as a civil penalty an amount not exceeding one hundred dollars (\$100) for each full calendar day of noncompliance. Contractor or its subcontractor, who knowingly commits a second or subsequent violation of Labor Code 1777.5 within a three-year period, where the noncompliance results in apprenticeship training not being provided as required, shall forfeit as a civil penalty the sum of not more than three hundred dollars (\$300) for each full calendar day of noncompliance. Upon the receipt of a determination that a civil penalty has been imposed by the Chief of the Division of Apprenticeship Standards, the District shall withhold the amount of the civil penalty from the next progress payment then due or to become due Contractor.

8.11.8 In case it becomes necessary for the Contractor or any subcontractor engaged in performance of the Work to employ on the Work any person in a trade or occupation (except executive, supervisory, administrative, clerical, or other non-manual workers as such) for which no minimum wage rate has been determined by the Director of the Department of Industrial Relations, the Contractor must pay the minimum rate of wages specified therein for the classification which most nearly corresponds to Work to be performed by that person. The minimum rate thus furnished will be applicable as a minimum for such trade or occupation from the time of the initial employment of the person affected and during the continuance of such employment.

8.11.9 Labor Discrimination. Attention is directed to Section 1735 of the Labor Code, which reads as follows:

"No discrimination shall be made in the employment of persons upon public works because of the race, religious creed, color, national origin, ancestry, physical disability, mental disability, medical condition, marital status, sex, age or sexual orientation of such persons, except as provided in Section 12940 of the Government Code, and every contractor for public works violating this section is subject to all the penalties imposed for violation of this chapter."

8.11.10 Receipt of Workers' Wages, Fee for Registering or Placing Persons In Public Works - Attention is directed to the provisions of sections 1778 and 1779 of the California Labor Code, which read as follows:

"Section 1778. Every person, who individually or as a representative of an awarding or public body or officer, or as a contractor or subcontractor doing public work, or agent or officer thereof, who takes, receives or conspires with another to take or receive, for its own use or the use of any other person any portion of the wages of any workman or working subcontractor, in connection with services rendered upon any public work is guilty of a felony."

"Section 1779. Any person or agent or officer thereof who charges, collects, or attempts to charge or collect, directly or indirectly, a fee or valuable consideration for registering any person for public work, or for giving information as to where such employment may be procured, or for placing, assisting in placing, or attempting to place, any person in public work, whether the person is to work directly for the state, or any political subdivision or for a contractor or subcontractor doing public work is guilty of a misdemeanor."

8.12 Laws and Ordinances. The Contractor and all subcontractors engaged in the performance of the Work must conform to the following specific rules and regulations as well as all other laws, ordinances, rules and regulations that apply to the Work. Nothing in the Technical Specifications or Drawings is to be construed to permit Work not conforming to these codes:

National Electrical Safety Code, U. S. Department of Commerce
National Board of Fire Underwriters' Regulations
California Building Standards Code as adopted by the District
Manual of Accident Prevention in Construction, latest edition, published by
A.G.C. of America

Industrial Accident Commission's Safety Orders, State of California
Regulations of the State Fire Marshall (Title 19, California Code of Regulation) and
Applicable Local Fire Safety Codes
Labor Code of the State of California - Division 2, Part 7, Public Works and Public
Agencies.

8.13 Guaranty. The Contractor guarantees all of the Work for one year from the date the District accepts the Work. Upon receiving written notice of a need for repairs which are directly attributable to defective materials or workmanship the Contractor must make good any defects arising or discovered in any part of the Work by diligently commencing the necessary repairs within seven (7) calendar days from the date of notice from the District. If the Contractor fails to make good any defects in the Work in accordance with this provision, in addition to any other available remedy under the contract or at law or equity, the District may make good or have made good such defects in the Work and deduct the cost from amounts that may be due or become due the Contractor, and for the cost of making good such defects and for the District's reasonable legal costs, if any, of recovering against the bond. The Contractor shall remain responsible for repairing any Work found to be defective regardless of when such defect is discovered by the District. See Drawings for other Guaranty/Warranty requirements for the project.

8.14 Safety.

8.14.1 Contractor's Safety Responsibility - The Contractor shall be solely and completely responsible for conditions of the jobsite, including safety of all persons and property during performance of the Work. This requirement shall apply continuously and not be limited to normal working hours. Safety provisions shall conform to U.S. Department of Labor (OSHA), the California Occupational Safety and Health Act (CalOSHA), and all other applicable Federal, State, County, and local laws, ordinances, codes, including but not limited to the requirements set forth below, and any regulations that may be detailed in other parts of these Contract Documents. In the event of conflicting requirements, the most stringent requirement as it pertains to the Contractor's safety responsibility, shall be followed by the Contractor.

No provision of the Contract Documents shall act to make the District, the Construction Manager, Design Consultant or any other party than the Contractor responsible for safety. The Contractor agrees that for purposes of California Labor Code Section 6400 and related provisions of law the Contractor, the Contractor's privities and any other entities acting pursuant to this contract will be "employers" responsible for furnishing employment and a place of employment that is safe and healthful for the employees, if any, of such entities acting pursuant to this contract and that neither the District nor the Construction Manager, Design Consultant or their respective officers, officials, employees, agents or volunteers or other authorized representatives will be responsible for having hazards corrected and /or removed at the location(s) where the work is to be performed. The Contractor agrees that neither the District nor the Construction Manager, Design Consultant or their respective officers, officials, employees, agents or volunteers or other authorized representatives will be responsible for taking steps to protect the Contractor's employees from such hazards, or for instructing the Contractor's employees to recognize such hazards or to avoid the associated dangers. The Contractor

agrees that with respect to the work to be performed under this contract and the location(s) where such work is to be performed, the Contractor will be responsible for not creating hazards, and for having hazards corrected and/or removed. The Contractor agrees that through the safety obligations contained in this contract and the Contractor's own inspection of the site(s) where the contract work is to be performed, the Contractor is aware and has been notified of the hazards to which the Contractor's employees may be exposed in the performance of contract work. The Contractor has taken and/or will take appropriate, feasible steps to protect the Contractor's employees from such hazards, and has instructed and/or will instruct its employees to recognize such hazards and how to avoid the associated dangers. The Contractor agrees that neither the District nor the Construction Manager, Design Consultant or their respective officers, officials, employees, agents or volunteers or other authorized representatives will be "employers" pursuant to California Labor Code Section 6400 and related provisions of law with respect to the Contractor, the Contractor's privities or other entities acting pursuant to this contract.

- 8.14.2 Review and inspection by the District, the District Engineer, the Architect or Engineer, and/or other representatives of the District of the Contractor's performance of the Work will not constitute review of the adequacy of the Contractor's safety measures in, on, or near the Work site. Such reviews and inspections do not relieve the Contractor of any of the Contractor's obligations under the Contract Documents and applicable law to ensure that the Work site is maintained and the Work is performed in a safe manner.
- 8.14.3 The Contractor will be solely responsible for the implementation and maintenance of safety programs to ensure that the Work site is maintained and the Work is performed in a safe manner in accordance with the Contract Documents and applicable law.
- 8.14.4 Safety Plan - Within seven (7) calendar days following Notice of Award the Contractor must submit to the District a copy of the Contractor's Safety Plan.

The Contractor shall establish, implement, and maintain a written injury prevention program as required by Labor Code Section 6401.7. Before beginning the Work, the Contractor shall prepare and file with the Construction Manager a written Contractor Safety Plan that provides for the implementation of all of the Contractor's safety responsibilities in connection with the Work at the Project site. The coordination of that program and its associated procedures and precautions with safety plans, precautions and procedures of each of its subcontractors and other Contractors performing work at the Project site. The Contractor shall be solely responsible for initiating, maintaining, monitoring, coordinating, and supervising all safety plans, precautions, and procedures in connection with the Work and for coordinating its programs, precautions, and procedures of the other contractors and subcontractors performing the Work at the Project site. The Safety Plan should contain all the necessary elements for the Contractor to administer its program on the Project site. At a minimum, this written Safety Plan shall address the elements required by Labor Code Section 6401.7.

The Contractor's compliance with requirements for safety and/or the Construction Manager's review of the Contractor's Safety Plan shall not relieve or decrease the liability of the Contractor for safety. The Construction Manager's review of the Contractor's Safety Plan is only to determine if the above listed elements are included in the program.

- 8.14.5 The Contractor must furnish and place proper guards and systems for the prevention of accidents, including, but not limited to, those systems required pursuant to Title 8, Section 1670 and following of the California Code of Regulations concerning safety belts and nets. The Contractor must provide and maintain any other necessary systems or devices required to secure safety of life or property at the Work site in accordance with accepted standards of the industry and applicable law. The Contractor must maintain during all night hours sufficient lights to prevent accident or damage to life or property.
- 8.14.6 The Contractor must comply with the District's Confined Space Entry Program shown in the Contract Documents.
- 8.14.7 The Contractor shall indemnify, defend and hold District and Construction Manager, Design Consultant and their respective officers, officials, employees, agents and volunteers or other authorized representatives harmless to the full extent permitted by law concerning liability related to the Contractor's safety obligations in accordance with the indemnification section of the Contract Documents.

If death or serious injuries or serious damages are caused, the accident shall be reported immediately by telephone or messenger to both the Construction Manager and the District. In addition, the Contractor shall furnish the Construction Manager with a copy of the Employer's Report of Injury immediately following any incident requiring the filing of said report during the prosecution of the Work under this Contract. The Contractor shall also furnish the Construction Manager with a copy of the Employer's Report of Injury involving any subcontractors on this Project. The Contractor shall make all reports as are, or may be, required by any authority having jurisdiction, and permit all safety inspections of the Work being performed under this Contract.

If a claim is made by anyone against the Contractor or any subcontractor on account of any accident, the Contractor shall promptly report the facts in writing to the Construction Manager, giving full details of the claim.

- 8.14.8 Safety Supervisor - The Contractor shall appoint an employee as safety supervisor who is qualified and authorized to supervise and enforce compliance with the Safety Program. The Contractor shall notify the Construction Manager in writing prior to the commencement of work of the name of the person who will act as the Contractor's Safety Supervisor and furnish the safety supervisor's resume to the Construction Manager.

Contractor will, through and with its Safety Supervisor, ensure that all of its employees, and its subcontractors of any tier, fully comply with the Project Safety Policies. The Safety Supervisor shall be a full-time employee of the Contractor whose responsibility shall be for supervising compliance with

applicable safety requirements on the Project site and for developing and implementing safety training classes for all job personnel. The District shall have the authority to require removal of the Contractor's Safety Supervisor if the representative is judged to be improperly or inadequately performing the duties; however, this authority shall not in any way affect the Contractor's sole responsibility for performing this work safely, nor shall it impose any obligation upon the District to ensure the Contractor performs its work safely.

8.14.9 Safety and Protection - The Contractor shall take all necessary precautions to prevent damage, injury, and loss to:

- All employees on the Project, employees of all subcontractors, and other persons and organizations who may be affected thereby;
- All the Work and materials and equipment to be incorporated therein, whether in storage on or off the site; and
- Other property at the site or adjacent thereto, including trees, shrubs, lawns, walks, wetlands, pavements, roadways, structures, utilities, and underground facilities not designated for removal, relocation, or replacement in the course of construction, even if not shown on the Contract Drawings.

The Contractor shall comply with all applicable laws and regulations of any public body having jurisdiction for the safety of persons or property or to protect them from damage, injury or loss and shall erect and maintain all necessary safeguards for such safety and protection. The Contractor shall notify owners of adjacent property and of underground facilities and utility districts when prosecution of the Work may affect them and shall cooperate with them in the protection, removal, relocation, and replacement of their property. All damage, injury or loss to any property caused, directly or indirectly, in whole or in part, by the Contractor, any subcontractor, supplier or any other person or organization directly or indirectly employed by any of them to perform or furnish any of the Work or anyone for whose acts any of them may be liable, shall be remedied by the Contractor, and the Contractor shall be responsible for any direct or indirect costs resulting from such damage, injury or loss.

8.14.10 Excavation Safety - In accordance with the provisions of Section 6705 of the Labor Code, the Contractor shall submit, in advance of excavation of any trench or trenches five feet or more in depth, a detailed plan showing the design of shoring, bracing, sloping, or other provisions to be made for worker protection from the hazard of caving ground during the excavation of such trench or trenches. If such plans vary from the shoring system standards set forth in the Construction Safety Orders of the Division of Industrial Safety in Title 8, Subchapter 4, Article 6, California Code of Regulations, the plans shall be prepared and signed by a registered civil or structural engineer employed by the Contractor, and all costs therefor shall be included in the price named in the Contract for completion of the work as set forth in the Contract Documents. Nothing in this section shall be deemed to allow the use of a shoring, bracing, sloping, or other protective system less effective than that required by the Construction Safety Orders. Nothing in this section shall be construed to impose a tort liability on the District, the Design Consultant, the Construction Manager, nor any of their officers, officials, employees, agents, consultants or

volunteers. The District's review of the Contractor's excavation plan is only for general conformance to the Construction Safety Orders.

Prior to commencing any excavation, the Contractor shall designate in writing to the Construction Manager the "competent person(s)" with the authority and responsibilities designated in the Construction Safety Orders.

8.14.11 Safety Emergencies - In emergencies affecting the safety or protection of persons or the Work or property at the Project site or adjacent thereto, the Contractor, without special instruction or authorization from the Construction Manager, is obligated to act to prevent threatened damage, injury or loss. The Contractor shall give the Construction Manager prompt written notice if the Contractor believes that any significant changes in the Work or variations from the Contract Documents have been caused thereby.

8.14.12 Safety Violations - Should the Contractor fail to correct an unsafe condition, the District shall have the right to notify the Contractor through the Construction Manager that an unsafe condition may exist and must be corrected or the work in question can be stopped in accordance with Section 7.8, Suspension of Work until the condition is corrected to the satisfaction of the District. No extension of time or additional compensation will be granted as a result of any stop order so issued. The notification and suspension of such work or the failure to provide such notification and suspension by the District shall not relieve the Contractor of its sole responsibility and liability for safety and the correction of any unsafe conditions.

The District shall have the authority to require the removal from the project of any worker and the foreman and/or superintendent in responsible charge of the work where safety violations occur.

8.14.13 Equipment Safety Provisions - The completed Work shall include all necessary permanent safety devices, such as machinery guards and similar safety items, required by the State and Federal (OSHA) industrial authorities and applicable local and national codes. Further, any features of the Work, including District -selected equipment, subject to such safety regulations shall be fabricated, furnished, and installed in compliance with these requirements. All equipment furnished shall be grounded and provided guards and protection as required by safety codes. Where vapor-tight or explosion-proof electrical installation is required by safety codes, this shall be provided. Contractors and manufacturers of equipment shall be held responsible for compliance with the requirements included herein. The Contractor shall notify all equipment suppliers and subcontractors of the provisions of this paragraph.

8.14.14 Confined Spaces – The Project requires work in confined spaces and requires compliance with CAL/OSHA and Federal OSHA requirements. Confined spaces for the purposes of this section shall be as defined by the Division of Industrial Safety. Notwithstanding any classifications relative to the Tunnel Safety Orders, work within confined spaces of this project is subject to the definitions and applicable provisions of Section 5156 et. seq., Title 8, Division 1, Chapter 4, Subchapter 7, Group 16, Article 108 of California Code of Regulations.

Entry into existing “permit” confined spaces as defined by OSHA shall be allowed only in compliance with a confined space entry permit program by the Contractor that meets the requirements of CAL/OSHA Section 5157. While the District has identified certain existing facilities as confined spaces other confined spaces may exist on the Project. It shall be the responsibility of the Contractor to identify and classify these confined spaces.

Sources of ignition, including smoking, shall be prohibited in any confined space.

It is anticipated that the Contractor may encounter hazardous conditions within these confined spaces which include, but are not limited to the following:

- A. Exposure to hydrogen sulfide, methane, carbon dioxide and other gases and vapors commonly found in municipal sewers which could have or has the potential of having Immediate Danger to Life or Health Conditions (IDLH).
- B. Exposure to atmosphere containing insufficient oxygen to support human life.
- C. Exposure to combustible, flammable and/or explosive atmosphere.
- D. Exposure to sewage which may contain bacteriological, chemical and other constituents harmful to humans.
- E. Work in conditions where engulfment or entrapment may occur.
- F. Work in environments which may be slippery and/or have uneven work surfaces.
- G. Work in structures which have limited and/or restricted access and egress.
- H. Work in structures where workers may trip, slip and/or fall several feet.
- I. See Appendices “Contractor Safe Work Requirements” and “Confined Space Entry Program” for additional requirements. Copies of confined space permits shall be submitted to the District weekly.

8.14.15 Construction Activity Permits - The Contractor must submit a copy of its respective current DOSH permit before beginning work on any the following construction activities:

- A. Construction of trenches or excavations which are five feet or deeper and into which a person is required to descend.
- B. Construction of any building, structure, scaffolding or falsework more than three stories high or the equivalent height (36 feet).

- C. Demolition of any building or structure, or dismantling of scaffolding or falsework more than three stories high or the equivalent height (36 feet).
- D. Erection or dismantling of vertical shoring systems more than three stories high, or the equivalent height (36 feet).

8.14.16 Public Safety and Convenience – In accordance with the provisions of Section 6500 of the Labor Code the Contractor shall conduct his work so as to ensure the least possible obstruction to traffic and inconvenience to the general public and the residents in the vicinity of the Work and to ensure the protection of persons and property. No road or street shall be closed to the public except with the permission of the Construction Manager and the proper governmental authority. Fire hydrants on or adjacent to the Work shall be accessible to firefighting equipment. Temporary provisions shall be made by the Contractor to ensure the use of sidewalks, private and public driveways and proper functioning of gutters, sewer inlets, drainage ditches and culverts, irrigation ditches and natural water courses. To the maximum extent permitted by law, Contractor shall indemnify, hold harmless and defend District from any and all liability, including attorneys' fees and costs of litigation, arising from any failure to comply with this section by Contractor or its privities.

8.15 Assignment of Unfair Business Practice Claims. In accordance with California Public Contract Code Section 7103.5, the Contractor and any subcontractors offer and agree to assign to the District all rights, title, and interest in and to all causes of action the Contractor or any subcontractors may have under Section 4 of the Clayton Act (15 U.S.C. § 15) or under the Cartwright Act (Chapter 2 (commencing with § 16700) of Part 2 of Division 7 of the Business and Professions Code), arising from purchases of goods, services or materials pursuant to this contract. This assignment shall be made and become effective at the time the District tenders final payment to the Contractor, without further acknowledgement by the parties.

9. MEASUREMENT AND PAYMENT

9.1 F.O.B. All shipments must be F.O.B. destination to the Work site and/or other sites indicated in the Contract Documents. The Contract Price is all-inclusive (including sales tax). There shall be no additional compensation paid for containers, packing, unpacking, drayage or insurance.

9.2 Payment

9.2.1 On or about the first day of each calendar month the Contractor will submit to the District Engineer a verified application for payment and schedule of values supported by a statement showing all materials actually installed during the preceding month and the cost of labor actually expended in the performance of the Work. Unless otherwise provided in the Contract Documents, no allowances or payments will be made for material or equipment not placed at the Work site.

9.2.2 To be eligible for payment the Contractor's applications for payment must include certified payroll reports prepared in accordance with California Labor Code Section 1776 and the Agreement for each employee of the Contractor

and any subcontractors engaged in the performance of the Work during the preceding months, applications for payment will not be processed without certified payroll reports.

- 9.2.3 In accordance with California Public Contract Code Section 20104.50, the District will review applications for payment as soon as practicable after receipt. Any application or part of an application that is determined to be improper will be returned to the Contractor as soon as practicable, but no later than seven (7) calendar days after receipt by the District, along with a written description of the reasons why the application is improper. The Contractor's failure to submit a schedule in the time specified in Section 3.8, or its submission of a schedule to which the District has taken any uncorrected exception, shall serve as a basis for returning an application for payment in its entirety.
- 9.2.4 Unless the Contractor has elected to post securities in lieu of retention in accordance with California Public Contract Code Section 22300 and the Agreement, and the Contractor and the District have executed an escrow agreement in accordance with the Public Contract Code and the Agreement, the District will make progress payments to the Contractor in accordance with applicable law in the amount of 95 percent of the value of the labor actually performed and the material incorporated in the Work as specified in Contractor's verified application for payment upon approval by the District's authorized representative(s). Payment of progress payments will not be construed as acceptance of the Work performed. If the Contractor has elected to post securities in lieu of retention in accordance with Public Contract Code Section 22300 and the Agreement and the Contractor and the District have executed an escrow agreement in accordance with the Public Contract Code and the Agreement, the District will make payments to the Contractor or the Contractor's escrow agent in accordance with such escrow agreement.
- 9.2.5 The District will pay the Contractor's final invoice in accordance with applicable law and this Section 9 following acceptance of the Work provided that:
- 9.2.5.1 The Contractor has furnished evidence satisfactory to the District that all claims for labor and material have been paid, or the time for filing valid stop notices has passed and no stop notices have been filed, or all stop notices filed have been released by valid release or release bond acceptable to the District.
- 9.2.5.2 No claim has been presented to the District by any person based upon any acts or omissions of the Contractor or any subcontractor engaged in the performance of the Work.
- 9.2.5.3 No other claim or dispute exists under the Agreement or applicable law concerning payment of the Contractor's final invoice and/or release of the Agreement retention.
- 9.2.5.5 The Contractor's application for final payment contains a written waiver of all claims against the District of which the Contractor may not yet asserted at the time of the submission of the application for final payment.

- 9.2.5.6 In accordance with California Public Contract Code Section 7107, the final payment or release of retention shall not be due and payable until the expiration of 35 days from the date of recording the Notice of Completion by the District.
- 9.2.6 In accordance with California Public Contract Code Section 20104.50, if the District fails to make a progress payment within 30 calendar days of receipt of an undisputed, properly submitted application for payment, the District will pay the Contractor interest equivalent to the legal rate set forth in subdivision (a) of California Code of Civil Procedure Section 685.010. The number of calendar days available to the District to make a payment without incurring an interest obligation pursuant to this provision and California Public Contract Code Section 20104.50 will be reduced by the number of calendar days, if any, by which the District has delayed return of an application for payment beyond the seven day return requirement set forth in Section 9.2.5.
- 9.3 Non-Allowable Direct Charges. The following costs are not allowable direct charges under the Agreement. The following costs may only be paid under the Agreement, if at all, as part of any allowance for contractor overhead and/or profit established under the Agreement.
 - 9.3.1 Labor costs in excess of applicable prevailing wages pursuant to the Agreement and applicable law, liability and workers compensation insurance, social security, retirement and unemployment insurance and other employee compensation and benefits pursuant to bona fide compensation plans in effect at the time specified for the opening of Project bids for contractor and subcontractor employees engaged in the performance of the Work. However, in no event will allowable direct labor charges under the agreement include employee bonuses, employee vehicles or vehicle allowances, employee telephones or telephone allowances, or employee housing or housing allowances, whether or not such benefits are part of a bona fide compensation plan in effect at the time specified for the opening of Project bids.
 - 9.3.2 Superintendent labor and clerical labor.
 - 9.3.3 Bond premiums
 - 9.3.4 Insurance in excess of that required under Section 8.8
 - 9.3.5 Utility costs
 - 9.3.6 Work Site office expenses
 - 9.3.7 Home office expenses.
- 9.4 Withhold. The District or its agent may, in accordance with the Contract Documents and applicable law, withhold any payment of monies due or that may become due the Contractor because of:
 - 9.4.1 Defective work not remedied or uncompleted work.
 - 9.4.2 Claims filed or reasonable evidence indicating probable filing of claims.

- 9.4.3 Failure to properly pay subcontractors or to pay for material or labor.
 - 9.4.4 Reasonable doubt that the Work can be completed for the balance then unpaid.
 - 9.4.5 Damage to another contractor.
 - 9.4.6 Damage to the District.
 - 9.4.7 Damage to a third party.
 - 9.4.8 Delay in the progress of the Work, which, in the District's judgment, is due to the failure of the Contractor to properly expedite the Work.
 - 9.4.9 Liquidated damages or other charges that apply to the Contractor under the Agreement.
 - 9.4.10 Any other lawful basis for withholding payment under the contract.
 - 9.4.11 Failure of the Contractor to maintain record documents and as-built drawings (as-needed).
 - 9.4.12 Cost of insurance arranged by the District due to cancellation or reduction of the Contractor's insurance.
 - 9.4.13 Failure to submit, revise, resubmit or otherwise conform to the requirements herein for preparing and maintaining a construction schedule.
 - 9.4.14 Failure to make proper submissions, as specified herein.
 - 9.4.15 Stop Notice claims filed by Contractor's subcontractors, of any tier, or its material suppliers.
 - 9.4.16 Provisions of law that enable or require the District to withhold such payments in whole or in part.
 - 9.4.17 Failure to comply with environmental or other regulatory requirements.
 - 9.4.18 Failure of Contractor to submit Operation and Maintenance Manuals.
- 9.5 Securities in Lieu of Retention.
- 9.5.1 In accordance with Public Contract Code Section 22300, except where federal regulations or polices do not permit substitution of securities, the Contractor may substitute securities for any moneys withheld by the District to ensure performance of the Work. At the Contractor's request and expense, securities equivalent to the amount withheld will be deposited with the District, or with a state or federally chartered bank in California as the escrow agent, who will then pay those moneys to the Contractor under the terms of an Escrow for Security Deposit agreement. The Escrow for Security Deposit agreement is provided in the Contract Documents. Upon satisfactory completion of the Work, the securities will be returned to the Contractor.

- 9.5.2 Alternatively, at the Contractor's request and expense, the District will pay retentions earned directly to the escrow agent. At the Contractor's expense, the Contractor may direct investment of the payments into securities. Upon satisfactory completion of the Work, the Contractor will receive from the escrow agent all securities, interest, and payments received by the escrow agent from the District pursuant to this provision and the terms of the Escrow for Security Deposit agreement. The Contractor will, within twenty (20) working days of receipt of payment, pay to each subcontractor the respective amount of interest earned, less costs of retention withheld from each Subcontractor, on monies withheld to ensure the Contractor's performance of the Work.
- 9.5.3 Securities eligible for investment in accordance with this provision include those listed in Government Code Section 16430, bank or savings and loan certificates of deposit, interest bearing demand deposit accounts, standby letters of credit, or any other security mutually agreed to by the Contractor and the District.
- 9.5.4 The Contractor will be the beneficial owner of any securities substituted for moneys withheld and will receive any interest thereon.

10. PROJECT ACCEPTANCE AND CLOSEOUT

- 10.1 Occupancy. The District reserves the right to occupy or use any part or parts or the entire of the Work before the Work is fully performed. Subject to applicable law, exercising this right will in no way constitute acceptance of any part of the Work so occupied or used or acceptance of the entire Work, nor will such occupancy or use in any way affect the times when payments will become due the Contractor, nor will such occupancy or use in any way prejudice the District's rights under the Agreement, any Agreement bonds, or at law or equity. Occupancy or use shall not waive the District's rights to assess liquidated damages in accordance with Section 7 after the date of such occupancy or use.
- 10.2 Work Completion and Final Inspection.
- 10.2.1 Certificate of Completion. When the Contractor considers the Work is completed, the Contractor will submit written certification to the District Engineer specifying that: the Contract Documents have been reviewed; the Work has been inspected for compliance with the Contract Documents; the Work has been completed in accordance with the Contract Documents; and that equipment and systems have been tested in the presence of the District's representative and are operational. The District and/or the District's authorized representatives will make an inspection to verify that the Work is complete and will notify the Contractor in writing of any incomplete or deficient Work. The Contractor will take immediate steps to remedy the stated deficiencies and give notice of correction to the District Engineer. Upon receiving a notice of correction, the District or the District's authorized representatives will re-inspect the Work. The Contractor must correct all punch list items within 15 working days after the issuance of the punch list.
- 10.2.2 Project Record Drawings/As-Built (**As Needed**). Before acceptance of the Work the Contractor must submit:

1. One set of Project Record Drawings, based on the Conformed Set, in 24 x 36 and 11 x 17 sheets.
2. Project Record Drawings, based on the Conformed Set, in AutoCad (.DWG) and portable document file (.PDF) formats.
3. Equipment operating and maintenance instructions and data: one set of hard copy, and one scanned set in portable document file (.PDF) format.
4. Miscellaneous construction-related documents, studies, reports, etc., obtained or developed by the contractor during construction of the project in portable document file (.PDF) format.
5. Warranties, etc.

10.3 Work Acceptance.

- 10.3.1 All finished Work will be subject to inspection and acceptance or rejection by the District, the District Engineer, and the Architect or Engineer and other government agencies having jurisdiction over the Work. Final acceptance of the Work will be at the discretion of the District.
- 10.3.2 The District will accept the Work in writing only when the Work has been completed to the District's reasonable satisfaction. Progress payments will in no way be construed as acceptance of any part of the Work.
- 10.3.3 In evaluating the Work, no allowance will be made for deviations from the Technical Specifications, Drawings or other Contract Documents unless already approved in writing in accordance with the requirements of Section 4, above.
- 10.3.4 The fact that the Work and materials have been inspected from time to time and that progress payments have been made does not relieve the Contractor of the responsibility of replacing and making good any defective or omitted work or materials in accordance with the requirements of the Contract Documents.

11. REMEDIES AND DISPUTES

- 11.1 Failure to Correct Work. Within ten (10) working days of receiving written notice from the District describing Work that is defective or that is otherwise not in accordance with the requirements of the Agreement and/or applicable law and directing that such Work be corrected, the Contractor and/or the Contractor's sureties must give the District written notice of the intent of the Contractor and/or the Contractor's sureties to correct such Work and commence correction of such Work in accordance with the District's notice and the Agreement. If the Contractor and/or the Contractor's sureties do not give the District written notice of intent to correct such Work and commence correction of such Work within ten (10) working days of receipt of the District's notice, then the District may correct such work and/or have such work corrected for the account and at the expense of the Contractor and/or its sureties, and the Contractor and/or its sureties will be liable to the District for any resulting excess cost. The District may, in addition to all other remedies that the District may have under the Agreement and at law or equity, deduct any such excess cost of completing the Work from amounts that are due or that may become due the contractor.

11.2 Termination.

- 11.2.1 In accordance with California Public Contract Code Section 7105, in addition to all other available remedies that the District may have under the Agreement,

and at law or equity, the District may terminate the Contractor's control of the Work:

11.2.1.1 If the Contractor or any of its subcontractors engaged in the performance of the Work fails to timely perform the Work and/or any of the Contractor's material obligations under the Contract Documents, including but not limited to submission of an acceptable schedule, that have accrued except for due to reasons beyond the control of the Contractor pursuant to the Contract Documents.

11.2.1.2 If the Contractor is adjudged bankrupt, or if it should make a general assignment for the benefit of creditors, or if a receiver should be appointed on account of its creditors.

11.2.1.3 If the Contractor or any of the subcontractors engaged in the performance of the Work persistently or repeatedly refuses or fails to supply enough properly skilled workmen or proper materials for the timely completion of the Work.

11.2.1.4 If the Contractor fails to make prompt payment to subcontractors engaged in the performance of the Work or for material or labor used in the performance of the Work in accordance with the Contract Documents and applicable law.

11.2.1.5 If the Contractor or any subcontractors engaged in the performance of the Work persistently disregards laws or ordinances applicable to the performance of the Work, or the instructions of the District, the District Engineer, the Architect, or other authorized representatives of the District.

11.2.1.6 For any reason or for no reason, at the District's sole discretion.

11.2.2 If the District intends to terminate the Contractor's control of the Work for any of the reasons specified in Sections 11.2.1.1 through 11.2.1.5, above, the District will immediately serve written notice to the Contractor and its sureties in accordance with the Contract Documents. Notice of the District's intent to terminate the Contractor's control of the Work will be given by registered or certified mail and specify the grounds for termination, the required cure and the time by which the cure must be effected. Upon receipt of notice of the District's intent to terminate the Contractor's control of the Work for any of the reasons specified in provisions 11.2.1.1 through 11.2.1.5, above, the Contractor will have ten (10) working days from receipt of the notice or a longer time specified in the notice to cure its default. If the Contractor does not affect the required cure by the time specified in the notice, the District will issue a written notice of termination to the Contractor and its sureties by registered or certified mail. The notice of termination will specify: that upon receipt of the notice the Contractor's right to perform or complete the Work, including on behalf of the Contractor's sureties, is terminated; that the Contractor's sureties will have the right to take over and complete the Work and perform all of the Contractor's remaining obligations that have accrued under the Agreement; and that if the Contractor's sureties do not both give the District written notice of their intention to take over and perform the Agreement and commence completion of the

Work and performance of all of the Contractor's remaining obligations that have accrued under the Agreement within ten (10) working days after receipt of notice of termination that the District may declare the Contractor's sureties in default and take over the completion of the Work or have the Work completed for the account and at the expense of the Contractor and its sureties, and the Contractor and its sureties will be liable to the District for any resulting excess cost. The District may, in addition to all other available remedies that the District may have under the Contract Documents and at law or equity, deduct any such excess cost of completing the Work from amounts that are due or that may become due the Contractor.

- 11.2.3 Upon termination of the Contractor's control of the Work for any of the reasons specified in Sections 11.2.1.1 - 11.2.1.5, the Contractor will, if so directed by the District, immediately remove from the Work site any and all materials and personal property belonging to the Contractor which have not been incorporated in the Work and the Contractor and its sureties will be liable upon their bond for all damages caused the District by reason of the Contractor's failure to complete the Work.
- 11.2.4 Upon termination of the Contractor's control of the Work for any of the reasons specified in provisions 11.2.1.1 through 11.2.1.5, above, the District reserves the right to refuse tender of the Contractor by any surety to complete the Work.
- 11.2.5 If the District completes or has completed any portion of, or the whole of the Work, following termination of the Contractor's control of the Work for any of the reasons specified in Sections 11.2.1.1 through 11.2.1.5, above, the District will neither be liable for nor account to the Contractor or the Contractor's sureties in any way for the time within which, or the manner in which such Work is performed, or for any changes made in such Work or for the money expended in satisfying claims and/or suits and/or other obligations in connection with completing the Work. If, following termination of the Contractor's control of the Work for any of the reasons specified in Sections 11.2.1.1 through 11.2.1.5, above, the unpaid balance of the Contract Price exceeds the expense of completing the Work, including compensation for additional legal, managerial and administrative services and all other amounts due for the completion of the Work and/or satisfaction of claims of the District and/or others arising out of the Agreement and any other charges that apply to the Contractor under the Agreement, the difference will be paid to the Contractor. If such expenses of completing the Work exceed the unpaid balance of the Contract Price, the Contractor or its sureties will pay the difference to the District.
- 11.2.6 If the Agreement or Contractor's control of the Work is terminated for any reason, no allowances or compensation will be granted for the loss of any anticipated profit by the Contractor.
- 11.2.7 In accordance with California Government Code Section 4410, in the event a national emergency occurs, and public work being performed by contract is stopped, directly or indirectly, because of the freezing or diversion of materials, equipment or labor, as the result of an order or a proclamation of the President of the United States, or of an order of any federal authority, and the circumstances or conditions are such that it is impracticable within a reasonable

time to proceed with a substantial portion of the work, then the District and the Contractor may, by written agreement, terminate the Agreement. In accordance with California Government Code Section 4411, such an agreement will include the terms and conditions of the termination of the contract and provision for the payment of compensation or money, if any, which either party will pay to the other or any other person, under the facts and circumstances in the case. Compensation to the Contractor will be determined on the basis of the reasonable value of the work done, including preparatory work. As an exception to the foregoing, in the case of any fully completed separate item or portion of the Work for which there is a separate contract price, the contract price shall control. The parties may in any other case adopt the contract price as the reasonable value of the work or any portion of the work done.

11.3 Disputes.

11.3.1 In accordance with California Public Contract Code Section 20104.2, the following procedures apply to claims of \$375,000 or less between the Contractor and the District:

11.3.1.1 The claim shall be in writing and include the documents necessary to substantiate the claim. Claims must be filed on or before the date of final payment. Nothing in this subdivision is intended to extend the time limit or supersede notice requirements otherwise provided by contract for the filing of claims.

11.3.1.2 For claims of less than fifty thousand dollars (\$50,000), the District shall respond in writing to any written claim within forty five (45) calendar days of receipt of the claim, or may request, in writing, within thirty (30) days of receipt of the claim, any additional documentation supporting the claim or relating to defenses to the claim the District may have against the Contractor.

11.3.1.2.1 If additional information is thereafter required, it shall be requested and provided pursuant to this subdivision, upon mutual agreement of the District and the Contractor.

11.3.1.2.2 The District's written response to the claim, as further documented, shall be submitted to the Contractor within fifteen (15) calendar days after receipt of the further documentation or within a period of time no greater than that taken by the Contractor in producing the additional information, whichever is greater.

11.3.1.3 For claims of over fifty thousand dollars (\$50,000) and less than or equal to three hundred seventy-five thousand dollars (\$375,000), the District shall respond in writing to all written claims within sixty (60) calendar days of receipt of the claim, or may request, in writing, within thirty (30) calendar days of receipt of the claim, any additional documentation supporting the claim or relating to defenses to the claim the District may have against the Contractor.

11.3.1.3.1 If additional information is thereafter required, it shall be requested and provided pursuant to this subdivision, upon mutual agreement of the District and the Contractor.

11.3.1.3.2 The District's written response to the claim, as further documented, shall be submitted to the Contractor within thirty (30) calendar days after receipt of the further documentation, or within a period of time no greater than that taken by the Contractor in producing the additional information or requested documentation, whichever is greater.

11.3.1.4 If the Contractor disputes the District's written response, or the District fails to respond within the time prescribed, the Contractor may so notify the District, in writing, either within fifteen (15) calendar days of receipt of the District's response or within fifteen (15) calendar days of the District's failure to respond within the time prescribed, respectively, and demand an informal conference to meet and confer for settlement of the issues in dispute. Upon a demand, the District shall schedule a meet and confer conference within thirty (30) calendar days for settlement of the dispute.

11.3.1.5 Following the meet and confer conference, if the claim or any portion remains in dispute, the Contractor may file a claim as provided in Chapter 1 (commencing with Section 900) and Chapter 2 (commencing with Section 910) of Part 3 of Division 3.6 of Title 1 of the Government Code. For purposes of those provisions, the running of the period of time within which a claim must be filed shall be tolled from the time the Contractor submits his or her written claim pursuant to subdivision (a) until the time that claim is denied as a result of the meet and confer process, including any period of time utilized by the meet and confer process.

11.3.1.6 This article does not apply to tort claims and nothing in this article is intended nor shall be construed to change the time periods for filing tort claims or actions specified by Chapter 1 (commencing with Section 900) and Chapter 2 (commencing with Section 910) of Part 3 of Division 3.6 of Title 1 of the Government Code.

11.3.2 In accordance with California Public Contract Code Section 20104.4, the following procedures apply to civil actions to resolve claims greater than \$375,000 between the District and the Contractor:

11.3.2.1 Within sixty (60) calendar days, but no earlier than thirty (30) calendar days, following the filing or responsive pleadings, the court shall submit the matter to non-binding mediation unless waived by mutual stipulation of both parties. The mediation process shall provide for the selection within fifteen (15) calendar days by both parties of a disinterested third person as mediator, shall be commenced within thirty (30) calendar days of the submittal, and shall be concluded within fifteen (15) calendar days from the commencement of the mediation unless a time requirement is extended upon a good cause showing to

the court or by stipulation of both parties. If the parties fail to select a mediator within the 15-day period, any party may petition the court to appoint the mediator.

11.3.2.2 If the matter remains in dispute, the case shall be submitted to judicial arbitration pursuant to Chapter 2.5 (commencing with Section 1141.10) of Title 3 of Part 3 of the Code of Civil Procedure, notwithstanding Section 1141.11 of that code. The Civil Discovery Act of 1986 (Article 3 (commencing with Section 2016) of Chapter 3 of Title 3 of Part 4 of the Code of Civil Procedure) shall apply to any proceeding brought under this subdivision consistent with the rules pertaining to judicial arbitration.

11.3.2.2.1 Notwithstanding any other provision of law, upon stipulation of the parties, arbitrators appointed for purposes of this article shall be experienced in construction law, and, upon stipulation of the parties, mediators and arbitrators shall be paid necessary and reasonable hourly rates of pay not to exceed their customary rate, and such fees and expenses shall be paid equally by the parties, except in the case of arbitration where the arbitrator, for good cause, determines a different division. In no event shall these fees or expenses be paid by state or county funds.

11.3.2.2.2 In addition to Chapter 2.5 (commencing with Section 1141.10) of Title 3 of Part 3 of the Code of Civil Procedure, any party who after receiving an arbitration award requests a trial de novo but does not obtain a more favorable judgment shall, in addition to payment of costs and fees under that chapter, pay the attorney's fees of the other party arising out of the trial de novo.

11.3.2.3 The court may, upon request by any party, order any witnesses to participate in the mediation or arbitration process.

11.3.3 In accordance with California Public Contract Code Section 20104.6:

11.3.3.1 The District shall not fail to pay money as to any portion of a claim which is undisputed except as otherwise provided in the contract.

11.3.3.2 In any suit filed under Public Contract Code Section 20104.4 concerning this contract, the District shall pay interest at the legal rate on any arbitration award or judgment. Such interest shall accrue from date the suit was filed.

11.3.4 Dispute Resolution in accordance with California Public Contract Code Section 9204:

11.3.4.1 Claims. This Section applies to and provides the exclusive procedures for any Claim arising from or related to the Contract or performance of the Work.

- (A) *Definition.* "Claim" means a separate demand by Contractor, submitted in writing by registered or certified mail with return receipt requested, for change in the Contract Time, including a time extension or relief from liquidated damages, or a change in the Contract Price, that has previously been submitted to District as a Change Order in accordance with the requirements of the Contract Documents, and which has been rejected or disputed by District, in whole or in part.
- (B) *Limitations.* A Claim may only include the portion of a previously rejected demand that remains in dispute between Contractor and District. With the exception of any dispute regarding the amount of money actually paid to Contractor as Final Payment, Contractor is not entitled to submit a Claim demanding a change in the Contract Time or the Contract Price, which has not previously been submitted to District in full compliance with this Section, and subsequently rejected in whole or in part by District.
- (C) *Scope of Section.* This Section is intended to provide the exclusive procedures for submission and resolution of Claims of any amount, and applies in addition to the provisions of Public Contract Code Section 9204 and Sections 20104 et seq., which are incorporated by reference herein.
- (D) *No Work Delay.* Notwithstanding the submission of a Claim or any other dispute between the parties related to the Project or the Contract Documents, Contractor must perform the Work and may not delay or cease Work pending resolution of the Claim or other dispute, but must continue to diligently prosecute the performance and timely completion of the Work, including the Work pertaining to the Claim or other dispute.

11.3.4.2 Claims Submission. The following requirements apply to any Claim subject to this Section:

- (A) *Substantiation.* The Claim must be submitted to District in writing, clearly identified as a "Claim" submitted pursuant to this Section 11.3.4, and must include all of the documents necessary to substantiate the Claim including the Change Order request that was rejected in whole or in part, and a copy of District's written rejection that is in dispute. The Claim must clearly identify and describe the dispute, including relevant references to applicable portions of the Contract Documents, and a chronology of relevant events. Any Claim for additional payment must include a complete, itemized breakdown of all labor, materials, taxes, insurance, and subcontract, or other costs. Substantiating documentation such as payroll records, receipts, invoices, or the like, must be submitted in support of each claimed cost. Any Claim for an extension of time or delay costs must be

substantiated with schedule analysis and narrative depicting and explaining claimed time impacts.

(B) *Claim Format.* A Claim must be submitted in the following format:

- (1) General introduction, specifically identifying the submission as a "Claim" submitted under this Section 11.3.4.
- (2) Relevant background information, including identification of the specific demand at issue, and the date of District's rejection of that demand.
- (3) Detailed explanation of the issue(s) in dispute. For multiple issues, separately number and identify each issue and include the following for each separate issue:
 - (a) The background of the issue, including references to relevant provisions of the Contract Documents;
 - (b) A succinct statement of the matter in dispute, including Contractor's position and the basis for that position;
 - (c) A chronology of relevant events;
 - (d) The identification and attachment of all supporting documents (see subsection (A), above, on Substantiation); and
 - (e) Use of a separate page for each issue.
- (4) Summary of issues and damage.
- (5) The following certification, executed by Contractor's authorized representative:

"The undersigned Contractor certifies under penalty of perjury that its statements and representations in this Claim are true and correct. Contractor warrants that this Claim is comprehensive and complete as to the matters in dispute, and agrees that any costs, expenses, or delay claim not included herein are deemed waived. Contractor understands that submission of a Claim which has no basis in fact or which Contractor knows to be false may violate the False Claims Act (Government Code Section 12650 et seq.)."

(C) *Submission Deadlines.*

- (1) A Claim must be submitted within 15 days of the date that District notified Contractor in writing that a request for a change in the Contract Time or Contract Price has been rejected in whole or in part.
- (2) With the exception of any dispute regarding the amount of Final Payment, any Claim must be filed on or before the date of Final Payment, or will be deemed waived.

- (3) A Claim disputing the amount of Final Payment must be submitted within 15 days of the effective date of Final Payment.
- (4) Strict compliance with these Claim submission deadlines is necessary to ensure that any dispute may be mitigated as soon as possible, and to facilitate cost-efficient administration of the Project. *Any Claim that is not submitted within the specified deadlines will be deemed waived by Contractor.*

11.3.4.3 District's Response. District will respond within 45 days of receipt of the Claim with a written statement identifying which portion(s) of the Claim are disputed, unless the 45- day period is extended by mutual agreement of District and Contractor or as otherwise allowed under Public Contract Code section 9204. However, if District determines that the Claim is not adequately documented, District may first request in writing, within 30 days of receipt of the Claim, any additional documentation supporting the Claim or relating to defenses to the Claim that District may have against the Claim. If Contractor fails to submit the additional documentation to District within 15 days of receipt of District's request, the Claim will be deemed waived.

- (A) *Additional Information*. If additional information is thereafter required, it may be requested and provided upon mutual agreement of District and Contractor.
- (B) *Non-Waiver*. *Any failure by District to respond within the times specified above may not be construed as acceptance of the Claim in whole or in part, or as a waiver of any provision of these Contract Documents.*

11.3.4.4 Meet and Confer. If Contractor disputes District's written response, or District fails to respond within 45 days of receipt of the Claim with, Contractor may notify District of the dispute in writing of the sent by registered or certified mail, return receipt requested, and demand an informal conference to meet and confer for settlement of the issues in dispute. If Contractor fails to dispute District's response in writing within the specified time, Contractor's Claim will be deemed waived.

- (A) *Schedule Meet and Confer*. Upon receipt of the demand to meet and confer, District will schedule the meet and confer conference to be held within 30 days, or later if needed to ensure the mutual availability of each of the individuals that each party requires to represent its interests at the meet and confer conference.
- (B) *Location for Meet and Confer*. The meet and confer conference will be scheduled at a location at or near District's principal office.

- (C) *Written Statement After Meet and Confer.* Within ten working days after the meet and confer has concluded, District will issue a written statement identifying which portion(s) of the Claim remain in dispute, if any.
- (D) *Submission to Mediation.* If the Claim or any portion remains in dispute following the meet and confer conference, within ten working days after the District issues the written statement identifying any portion(s) of the Claim remaining in dispute, the disputed portion(s) will be submitted for mediation, as set forth below.

11.3.4.5 Mediation and Government Code Claims.

- (A) *Mediation.* Within ten working days after the District issues the written statement identifying any portion(s) of the Claim remaining in dispute following the meet and confer, District and Contractor will mutually agree to a mediator, as provided under Public Contract Code section 9204. Mediation will be scheduled to ensure the mutual availability of the selected mediator and all of the individuals that each party requires to represent its interests. The parties will share the costs of mediation equally, except costs incurred by each party for its representation by legal counsel or any other consultants.
- (B) *Government Code Claims.*

- (1) Timely presentment of a Government Code Claim is a condition precedent to filing any legal action based on or arising from the Contract.
- (2) The time for filing a Government Code Claim will be tolled from the time Contractor submits its written Claim until the time that Claim is denied in whole or in part at the conclusion of the meet and confer process, including any period of time used by the meet and confer process. However, if the Claim is submitted to mediation, the time for filing a Government Code Claim will be tolled until conclusion of the mediation, including any continuations, if the Claim is not fully resolved by mutual agreement of the parties during the mediation or any continuation of the mediation.

11.3.4.6 Tort Claims. This Section does not apply to tort claims and nothing in this Section is intended nor will be construed to change the time periods for filing tort-based Government Code Claims.

11.3.4.7 Arbitration. It is expressly agreed, under California Code of Civil Procedure Section 1296, that in any arbitration to resolve a dispute relating to this Contract, the arbitrator's award must be supported by law and substantial evidence.

11.3.4.8 Damages. Contractor bears the burden of proving entitlement to and the amount of any claimed damages. Contractor is not entitled to damages calculated on a total cost basis, but must prove actual damages. Contractor is not entitled to recovery of any alleged home office overhead. The Eichleay Formula or

similar formula may not be used for any recovery under the Contract. Contractor is not entitled to consequential damages, including home office overhead or any form of overhead not directly incurred at the Worksite; lost profits; loss of productivity; lost opportunity to work on other projects; diminished bonding capacity; increased cost of financing for the Project; extended capital costs; non-availability of labor, material or equipment due to delays; or any other indirect loss arising from the Contract.

- 11.3.4.9 Multiple Claims. In the interest of efficiency, District, acting in its sole discretion, may elect to process multiple Claims concurrently, in which case the applicable procedures above will be based on the total amount of such Claims rather than the amount of each individual Claim. Any such election will not operate to change or waive any other requirements of this Section.
- 11.3.4.10 Other Disputes. The procedures in this Section 11.3.4 will apply to any and all disputes or legal actions, in addition to Claims, arising from or related to this Contract, unless and only to the extent that compliance with a procedural requirement is expressly and specifically waived by District.

THIS PAGE LEFT INTENTIONALLY BLANK

Las Gallinas Valley Sanitary District



Contractor Health and Safety Program



45950 Hotchkiss St. • Fremont, CA 94539 • (510) 651-8289 • du-all.com

Page Left Blank

Contractor Acknowledgement

I have read and fully understand the requirements of this Contractor Health and Safety Program and agree to comply.

Name: _____

Signature: _____

Company: _____

Date: _____

1.0 TABLE OF CONTENTS

<u>Section</u>	<u>Page</u>
1.0 TABLE OF CONTENTS	IV
2.0 REVISION HISTORY LOG	V
3.0 POLICY	1
4.0 SCOPE	2
5.0 FACILITY MANAGEMENT RESPONSIBILITIES	3
6.0 CONTRACTOR RESPONSIBILITIES	3
7.0 SPECIFIC SITE HAZARDS	5
8.0 SPECIFIC SAFETY AND HEALTH PROGRAM REQUIREMENTS	7
CODE OF SAFE PRACTICES	7
9.0 SAFETY COMMUNICATIONS	22
10.0 INJURY AND ILLNESS REPORTING	23
11.0 PERIODIC INSPECTIONS	23
12.0 HAZARD IDENTIFICATION AND CORRECTION	24
13.0 RECORDKEEPING REQUIREMENTS	24
14.0 PERIODIC PROGRAM EVALUATION	25

APPENDIX A- Wastewater Treatment Plant Map

APPENDIX B- Definitions

3.0 POLICY

It is the policy of the Las Gallinas Valley Sanitary District to provide employers, District employees and worker representatives with a sound, flexible framework for addressing safety and health issues in diverse workplaces. This Contractor Safety Program shall be used as a proactive approach to managing contractor workplace safety and health. This policy requires commitment to safety and health and the cooperative atmosphere between management, contractors and the Las Gallinas Valley Sanitary District employees. The chart below outlines the core elements of the Las Gallinas Valley Sanitary District's Contractor Health and Safety Program.

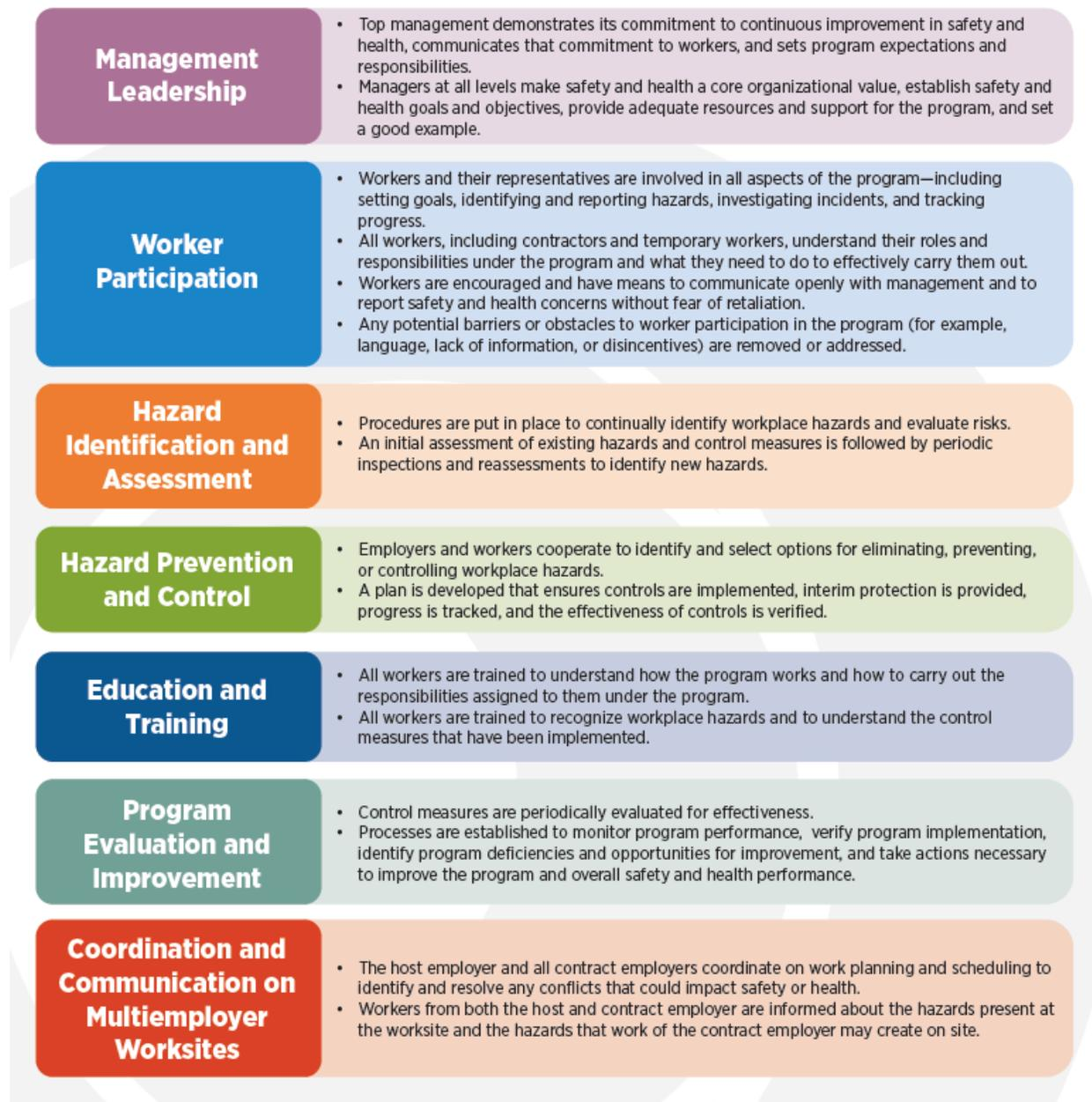

4.0 SCOPE

This program applies to all general contractors and sub-contractors and performing work for the Las Gallinas Valley Sanitary District. Before the start of any on-site work, the host employer and contractor or subcontractor shall establish their respective safety and health responsibilities and obligations, as well as procedures for coordinating these responsibilities and communicating safety and health information effectively.

Contractors or subcontractors working for the Las Gallinas Valley Sanitary District shall:

- a. Comply with all applicable federal, state, and local safety orders in the performance of any work on District projects.
- b. Comply with all safety regulations and procedures listed in this Contractor Health and Safety Program.
- c. Take any additional precautions necessary to prevent injury or damage to persons, property, or interference with District operations.

Contractors and subcontractors are responsible for notifying employees, subcontractors, and invitees of these District Safe Work Policies. No work within District facilities or on District contract work sites shall begin prior to such notification. Contractors and subcontractors shall not allow a new employee or new subcontractor to begin work on District projects without having conducted a full and proper safety orientation.

Contractors and subcontractors performing work at the Wastewater Treatment Plant facility, lift stations or sewage conveyance systems shall schedule a safety orientation session for their site Superintendent and other contractor-designated personnel with the Authorized District Representative prior to commencing work. This orientation session shall include:

- a. Emergency response and evacuation procedures.
- b. An explanation of applicable District safety policies, and any unique and inherent hazards of District facilities. Site specific hazards are identified in Section 7 of this Contractor Health and Safety Program.
- c. Traffic control planning and execution.

It is the responsibility of the contractor's or subcontractor's Superintendent or designated personnel to orient and so inform all personnel under the contractor's or subcontractor's supervision. The District may, in its sole discretion, either temporarily or permanently remove a contractor's or subcontractor's employee from District work and/or terminate the contractor's or subcontractor's right to proceed for any violation of applicable Cal/OSHA General Industry and Construction Industry Safety Orders or these District Safe Work Policies.

5.0 FACILITY MANAGEMENT RESPONSIBILITIES

Las Gallinas Valley Sanitary District Facility Management is responsible for implementation of the Contractor Health and Safety Program. Facility Management responsibilities and duties include but are not limited to:

- a. Communicate to temporary and contract employers and workers the commitment to provide the maximum level of safety and health protection.
- b. Provide a copy of the Health and Safety Program to all contractors.
- c. Inform contract employees of the Emergency Action Plan procedures to follow including building/facility evacuation route maps, assembly areas and the requirement to follow orders to evacuate.
- d. Identify any safety and health qualifications and certifications needed by on-site workers and ensure they meet such requirements.
- e. Provide sufficient resources to implement the Health and Safety program.
- f. Periodically review the program for effectiveness and implement changes as needed.
- g. Document these reviews in writing and maintain all records.
- h. Before beginning on-site work (including, where appropriate, as part of requests for proposals, bids, and contracts), clarify each employer's responsibilities and obligations with respect to safety and health, such as:
 - Providing written copies of required safety programs and plans
 - Providing necessary training and education to workers
 - Selecting, providing, and maintaining any Personal Protective Equipment (PPE).
 - Providing any required medical surveillance or evaluations.
 - Recording and reporting any injuries or illnesses.
 - Outline the procedures and processes for coordinating safety and health responsibilities, as well as and the procedures for communicating between the host employer and contractor or subcontractor.

6.0 CONTRACTOR RESPONSIBILITIES

Contractors and subcontractors are responsible to follow the requirements and procedures outlined in this program. Responsibilities and duties include but are not limited to:

- a. Provide Las Gallinas Valley Sanitary District with a copy of the employer's written Injury and Illness Prevention Program containing the key elements outlined in Cal CAL/OSHA Title 8, CCR Section 3203.

- b. Provide Las Gallinas Valley Sanitary District with a copy of any other required written safety program or plan including but not limited to:
- Fall Protection
 - Confined Space Entry
 - Respiratory Protection
 - Hot Work
 - Hazard Communication
 - Bloodborne Pathogen/Exposure Control
 - Heat Illness Prevention
 - LOTO
 - Silica Exposure Control
 - Traffic Control Plan
 - Covid 19 Prevention
- c. Before beginning on-site work, the contractor or subcontractor gives the host employer similar information about measures, programs, and procedures to be used to control hazards associated with their workers' work, and to ensure they comply with applicable Cal/OSHA standards.
- d. Identify any safety and health qualifications and certifications needed by on-site workers and ensure they meet such requirements.
- e. Work safely and follow Cal/OSHA safety standards and Las Gallinas Valley Sanitary District's operating policies, procedures, and safety programs.
- f. Coordinate access to the facility with Las Gallinas Valley Sanitary District Facilities Management.
- g. Perform periodic documented inspections to identify and correct hazards. Evidence of documented inspections shall be provided to Las Gallinas Valley Sanitary District upon request.
- h. Report to Las Gallinas Valley Sanitary District Facility Management any hazard detected requiring further action to correct.
- i. Report all occupational related injuries, illness or exposures to the Las Gallinas Valley Sanitary District Facility Management promptly.
- j. Selecting, providing, and maintaining employee PPE.
- k. Providing required medical assessments and surveillance.
- l. Provide required employee safety training and education to affected and authorized employees and supervisors.
- m. Provide accessible first aid supplies and if applicable, eye wash supplies spill clean-up supplies/equipment and portable fire extinguishers.

- n. Ensure all tools and equipment in use is inspected periodically, complies with all applicable Cal/OSHA, ANSI, ASME, NIOSH or other regulating agency requirements.
- o. Exchanging data on metrics each employer has tracked and using this data to evaluate the program's effectiveness at identifying and eliminating or controlling hazards.

7.0 SPECIFIC SITE HAZARDS

Contractors and subcontractors performing work at the Wastewater Treatment Plant facility, lift stations or sewage conveyance systems shall be informed if the site-specific hazards present. Site specific hazards include but are not limited to the following:

DISTRICT FACILITIES AND EQUIPMENT

Contractor's use of District instruments, tools, ladders, scaffolding or other equipment is not permitted except in cases of emergency as determined by a District supervisor or by permission from a senior Manager of the District.

Employee drinking water shall be supplied by the contractor or subcontractor. ***Do Not Drink Water from Hose Connections at any District Facility.*** Hose bib connections are located throughout the treatment plant. Most of these bibs supply treated wastewater and may or may not be posted with signs reading "Do Not Drink." In any case, ***never*** drink water from hose bibs or hoses.

Water lines throughout the treatment plant are color coded (when not stainless steel) and labeled as follows:

- Purple- Recycle Water Piping
- Blue- Domestic Water Piping
- Grey- Service Water Piping (Plant Effluent)

Hose connections may be used to wash down equipment. Never hose down electrical or heated equipment of any kind. If an employee has used a gray or purple water hose for wash down, he/she should, when done, immediately wash their hands in domestic water with soap and water.

NEVER make any connection to any water line without first verifying with the **Authorized District Representative** that contamination of the water lines will not occur.

ELECTRICAL SUPPLY SYSTEMS

The treatment plant's Electrical Supply System consists of one 1 MW and two 65kW Gas Microturbine Generators, one 500kW diesel oil engine driven standby generator and one 380 KW trailer mounted standby generator, and solar power. All electrical power generated in the plant and PG&E power (beyond their transformer) is 480-volt, 3-phase, 60 Hz electricity and is delivered to one 480-volt switchgear panel. This panel is interconnected by cables and protected by breakers, relays, and monitoring devices. Electricity is dispersed from the switchgear through breakers and cables to motor control centers (MCC's), to power panels, to transformers (voltage reducers), to lighting panels and to motor driven pumps and equipment. Lockable control stations are located at each piece of equipment. 480-volt, 208-volt and 120-volt electricity is used in the plant. Contact the duty operator prior to working on any piece of electrical equipment. Electricity is hazardous and can burn or kill people. All work on electrical systems shall be done in accordance with the State of California, CAL/OSHA, Article 33, Electrical Requirements for construction work, Low Voltage Electrical Safety Orders.

FERROUS CHLORIDE SYSTEMS

The Ferrous Chloride System consists of a positive displacement pump with feed rate adjustment. Shut-off valves are located before and after the pump. Before working on this system, close all valves and disconnect the pump from electricity. Ferrous Chloride is a dangerous chemical which will attack the skin, eyes and the mucous membranes of the mouth, throat, and lungs. Contact the plant duty operator prior to working on this system.

DIGESTER GAS SYSTEM

The Digester Gas System consists of one steel tank, associated piping, compressors, flare, etc. Sludge is bacterially reduced in the tanks creating principally methane (CH₄) and other combustible hazardous gases, including hydrogen sulfide (H₂S). Hydrogen sulfide is toxic at very low concentrations. These gases are contained by the tank covers and piping which is located on overhead racks, in pipe trenches and buried throughout the plant. The gases are burned in two large turbines driving generators to make electricity for the plant. Heat from the two turbines is captured and piped to the digesters to heat the sludge, speeding up the digestion process. Digesters and the stored gases within them are hazardous. No smoking, cutting, or spark generating equipment is allowed on or within ten feet of any digester. Contact the duty operator prior to working on digesters.

HYPOCHLORITE SYSTEM

Hypochlorite, or concentrated chlorine bleach (12.5%), is used to disinfect, or kill bacteria and virus in the final effluent (water) discharged from the plant. Two tanks, each 7,000 gallons are used to store hypochlorite. Piping, valves, pumps, strainers (filters) and flow-measuring and control equipment make up the system. Hypochlorite

will attack clothing, skin, eyes and mucous membranes of the nose, mouth, throat and lungs. Contact the duty operator prior to working on the hypochlorite system.

SODIUM BISULFITE

Sodium bisulfite is used when neutralizing sodium hypochlorite. Two 4,350 gallon tanks are used to store sodium bisulfite. Piping, valves, pumps, strainers (filters) and flow-measuring and control equipment make up the system. Sodium bisulfite is an irritant to eyes, skin and mucous membranes. Inhalation of mist may cause irritation to respiratory tract. Contact the duty operator prior to working on the sodium bisulfite system.

GENERAL HAZARDS

Throughout District's treatment plant and facilities there are a number of extremely hazardous elements considered to be dangerous to humans and the environment. They include, but are not limited, to:

- Permit Required Confined Spaces
- Flammable gas and petroleum.
- H₂S (hydrogen sulfite)
- Deep pools of liquid sewage which are rarely patrolled, and for which self-rescue is unlikely
- Automatic start equipment
- HBV (Hepatitis B Virus)
- Biting and stinging insects and animals

8.0 SPECIFIC SAFETY AND HEALTH PROGRAM REQUIREMENTS

CODE OF SAFE PRACTICES

All employees are expected to perform their jobs to the best of their ability as well as perform them in a safe manner. It is critical that employees do not circumvent safety features and employ unsafe work behaviors that can cause them or others to be at risk. CAL/OSHA requires that we furnish employees a place of employment "free from known and recognized hazards and unsanitary conditions that are causing or are likely to cause death or serious physical harm to employees."

Employee responsibilities for safety include the following:

- a. Practice safe work habits and follow your supervisor's instructions, company safety policies and Cal/OSHA regulations.
- b. Report unsafe conditions to your supervisor immediately.

- c. Wear and maintain appropriate PPE and other safety equipment in sanitary and usable condition as required by your employer and in accordance with manufacturer's recommendations.
- d. Maintain equipment in good condition with all safety features in place when in operation. Notify your supervisor if problems develop. Do not try to fix or jury rig equipment in the field.
- e. Report all incidents, accidents and near misses to your supervisor immediately, whether or not an injury resulted.
- f. Participate in safety by attending toolbox talks and other meetings as required by your supervisor. Your suggestions for improvement will assist in making our program more effective.

Emergency Action Plan (EAP)

Contractors and subcontractors shall be responsible for providing first aid and medical treatment for their employees and for compliance with the first aid requirements specified in Cal/OSHA Construction Safety Title 8 CCR Section 1512, Emergency Medical Services. Contractors shall be responsible for making prior arrangements for emergency medical care and for transportation of injured Contractor personnel.

Contractors and subcontractors shall plan and prepare for anticipated emergencies. In preparation for an on-site emergency, the contractor or subcontractor will institute the following procedures:

- a. Establish a method of emergency notification at the beginning of each job so that any worker can raise the alarm, alerting their supervisor and appropriate management of an emergency.
- b. Post and communicate this procedure to everyone on site. Las Gallinas Valley Sanitary District Facility Management will provide required information and resources to accomplish this.
- c. Establish a method to notify all workers on site of the need to evacuate the building/facility. Fire alarm pull stations, air horns and two-way radios are common options.
- d. Designate primary and secondary assembly areas for all workers to gather in the event of an emergency evacuation. This will allow each contractor to ensure that their employees have gotten out and are accounted for.
- e. Post these three emergency telephone numbers. In most cases 911 will get response from all three services, but it may vary by job site location.
 - Police
 - Fire
 - Medical Response Team

- f. When cellular service is not available, install a hard wire phone. Post emergency phone numbers at the telephone's location, along with the address of the job site.
- g. Designate a person to direct emergency crews from the gate to the specific emergency area.

Personal Protective Equipment (PPE)

The employer is required to instruct employees when to wear PPE. Supervisors are responsible for enforcing the use of PPE by all employees. PPE is considered the last line of defense providing limited protection to employees from injury or exposure. The contractor or subcontractor are required to perform a job hazard analysis to identify hazards and engineering and administrative hazard controls. If the hazard is not reduced to an acceptable level, PPE must be used. The following PPE may be required by the Las Gallinas Valley Sanitary District while performing work on Las Gallinas Valley Sanitary District facilities:

- Head, eye and face protection
- Body protection
- Hand protection
- Ergonomic protection
- Hearing protection
- Safety boots or shoes
- High visibility apparel
- Fall protection
- Respiratory protection

Fire Prevention

Fire prevention is of the highest priority. Contractors and subcontractors shall take appropriate measures to prevent fires at all times. Smoking is not allowed on any District facility at any time.

When work is being performed which generates sparks or open flames, the contractor or subcontractor will provide a fire watch, a person trained in the use of appropriate fire-fighting equipment, as needed, and whose only task is to observe and extinguish fires.

A District "Hot Work" permit must be filled out and turned into the Collection System / Safety Manager, or Plant Manager when the Safety Manager is not available, when work is completed. Hot Work Permits are valid for one day only.

Contractors and subcontractors shall ensure that appropriate fire extinguisher(s) are available at the specific work site for use in case of a fire. All Contractor's employees

shall be properly trained to use them. While conducting Hot Work, a minimum of a 2A-20-BC fire extinguisher shall be within 30' of the work location.

In the event of a fire, the contractor or subcontractor shall immediately notify the nearest District employee and if possible, call emergency (911) and give the location of the plant, which is 300 Smith Ranch Rd. San Rafael. A map of the wastewater plant is included in this policy (Attachment A).

The following fire prevention rules and requirements shall be followed:

- a. Open flames or fires are prohibited at all times except under the Hot Work Permit System.
- b. Any job or task that creates sparks, flames or heat sources enough to start a fire must be coordinated with the Las Gallinas Valley Sanitary District Facility Management and follow the Las Gallinas Valley Sanitary District Hot Work Program to determine if a Hot Work permit and fire watch is warranted.
- c. Follow the Las Gallinas Valley Sanitary District fire prevention program throughout all phases of work to assure that effective firefighting equipment is immediately available and designed to effectively meet all anticipated fire hazards.
- d. Store materials so they do not obstruct exits. Materials shall be stored with due regard to their fire characteristics; oxygen and acetylene cylinders shall never be stored at an exit or in emergency egress routes and must be stored at least 20' apart. Clearance of at least 36 inches shall be maintained for lights, heating units and electrical boxes.
- e. When practical, objects to be welded, cut or heated should be moved to a designated safe location. If the object cannot be moved, positive means shall be taken to confine the heat, sparks and slag and protect adjacent combustible materials.
- f. All extinguishers must be prominently placed, labeled for use and kept clear of obstructions at all times.
- g. If a fire extinguisher is used or is found discharged, report it to the supervisor immediately so it can be serviced. A replacement extinguisher should be mounted immediately.
- h. Fire extinguishers shall be inspected on a monthly basis. The date and inspector's initials on the tag document the inspection.
- i. When the fire signal (alarm) sounds, exit the building/facility and gather at the designated assembly point. Do not try to take tools or personal belongings with you, exit immediately.
- j. No smoking will be strictly enforced in all areas where "No Smoking" signs are posted,
- k. Personal appliances including hot plates and space heaters are prohibited.

Flammable and Combustible Liquids

Flammable and combustible liquids shall be stored, transferred and used in accordance with the following requirements below:

- a. Only approved containers will be used for the storage and handling of flammable and combustible liquids. Flammables, including gasoline, will be stored in approved safety cans. Containers shall be closed tightly at all times, except when transferring product.
- b. Under no circumstances will gasoline or other high flash-point flammables be utilized as a cleaning solvent.
- c. When not in use and at the end of the workday, all flammable liquid containers will be placed in the flammable liquid storage cabinets.
- d. Flammable or combustible liquids that have leaked or spilled shall be cleaned up immediately and disposed of per the supervisor's instructions.
- e. There shall be no smoking, open flame or use of flammable or combustible liquids in the area of storage. All employees must observe company restrictions on where and when smoking is acceptable.
- f. Isolate all combustible and flammable materials and solvents from possible ignition sources such as open flames, heated surfaces, electric arcs and sparks, mechanical sparks, static electricity, and self-heating materials. In short, all energy sources (mechanical, electrical, chemical, thermal, radiation) should be considered as potential ignition sources.

Hazard Communication-GHS

Any contractor or subcontractor whose employees will be bringing onto Las Gallinas Valley Sanitary District Facility grounds any hazardous chemicals, products or materials shall have a written Hazard Communication Program in compliance with Title 8 CCR Section 5194. The contractor or subcontractor shall provide to the Las Gallinas Valley Sanitary District the following:

- a. An inventory of hazardous products, chemicals and materials to be used.
- b. Safety Data Sheets for items mentioned above.
- c. A copy of the employer's written Hazard Communication Program.

Any contractor or subcontractor whose employees will be bringing onto Las Gallinas Valley Sanitary District Facility grounds any hazardous chemicals, products or materials shall ensure the following:

- a. All hazardous chemicals, products and materials are stored properly and are visibly and legibly labeled and in proper storage containers and cabinets.
- b. All exposed employees are trained in the employer's Hazard Communication Program

- c. All employees have access to Safety Data Sheets.
- d. Hazardous work areas are signed and barricaded with ample HAZCOM signage.

The Las Gallinas Valley Sanitary District Facility Management will provide the following to any contractor or subcontractor whose employees will be working in Las Gallinas Valley Sanitary District Facility grounds and are exposed to hazardous substances:

- a. A list of the hazardous chemicals, products and materials that exist on the premises.
- b. Access to Safety Data Sheets for items mentioned above.
- c. Orientation to the location of facility eye wash and drenching shower facilities.

Electrical Safety

Electrical hazards shall be identified and controlled prior to conducting any work activities that expose employees to such hazards. The following safe work practices and policies shall be followed:

- a. Treat all electrical circuits and equipment as energized until zero energy state has been verified.
- b. Do not attempt to adjust or repair any electrical device unless it is part of your regular job assignment. Bring observed hazards and maintenance needs to the attention of your supervisor as soon as possible.
- c. Follow all Las Gallinas Valley Sanitary District lockout/tagout procedures when repairs, maintenance or servicing activities are necessary. Be sure to keep machines and powered equipment in a “zero energy state” when performing service or setup.
- d. Keep covers to all electrical fixtures and wiring in place at all times, unless temporarily removed for servicing by qualified persons. We consider only Electricians to be qualified persons for electrical exposures.
- e. Only qualified persons may reset breakers in an open panel box or enter an electric room with open panels.
- f. Do not attach flexible cords to a wall, ceiling, door or other building surface.
- g. Extension cords must be a three-wire flexible cord. The grounding (third) prong must be present.
- h. Do not use metal ladders when electrical hazards are present. Use a fiberglass ladder.
- i. Stationary and portable electric power tools shall be double-insulated or electrically grounded via a third wire. A double-insulated tool will be identified on the tool’s label

- j. Ground fault circuit interrupters (GFCI) will be used on all job sites. A breaker or outlet type GFCI will be used for all new work. If a portable GFCI is used, it will be plugged directly into an outlet that is part of the permanent wiring. Never use an extension cord between the permanent wiring and the portable GFCI
- k. All temporary illumination systems shall be elevated above the working surface and all bulbs protected.
- l. Never use electrical equipment in wet or damp areas unless the equipment is approved for use in these areas and suitable PPE is utilized,

Working at Elevated Locations and Fall Protection

Fall hazards are common in the construction industry and a leading cause of injuries and fatalities. The hierarchy of controls indicates that fall hazard elimination is the highest priority. Subsequently, passive fall protective systems (guardrails) shall be used to prevent falls. If this is not feasible, a fall restraint system shall be utilized. Fall arrest systems may be used at elevated work locations greater than 18' above the lower level. If fall arrest systems are in use, the contractor or subcontractor shall submit to the District representative a written comprehensive rescue plan.

It is the policy of the Las Gallinas Valley Sanitary District to maintain 100% fall protection at all times. The following basic fall protection requirements shall be followed and enforced:

- a. Fall protection is required when work is conducted from elevating work platforms including scissor lifts, boom lifts, bucket trucks and any time employees are elevated in a personnel cage by crane or forklift.
- b. A competent person shall calculate total fall distance and ensure that the fall protection system used will adequately protect the user.
- c. Do not remove guardrails or perimeter cables without authorization from your supervisor. Once guardrails or cables are removed, fall protection is required.
- d. Fall arrest or restraint equipment is required whenever you could fall more than 4 feet (General Industry) or 7.5' (Construction Industry) and there are no guard rails or other forms of fall prevention in place. Training on how to inspect, wear and attach fall arrest equipment must be completed before you are expected to use it,
- e. Discuss proper anchorage points to be used with your supervisor or qualified person before starting the task.
- f. Employees working below elevating work platforms, scaffolds or similar shall be protected from being struck by falling object by using toe-boards, tool lanyards, canopies, nets or other suitable protective measures.
- g. Proper housekeeping practices shall be implemented at all times to prevent slip, trip and fall hazards.
- h. Uncontrolled fall hazards shall be reported immediately and access to the fall hazard controlled until the hazard is eliminated.

Confined Space Entry

No employee shall enter the areas defined below until a competent person evaluates the area and authorizes entry. All confined space entry work shall be coordinated with the Las Gallinas Valley Sanitary District Facility Management in advance of the entry. All confined space entry work shall comply the Las Gallinas Valley Sanitary District written Confined Space Entry Procedures.

A confined space is:

1. Must be **large enough and configured** such that an employee can bodily enter and perform work.
2. A space that is **not designed for continuous** employee occupancy.
3. Has **limited or restricted** means for entry or exit.
4. Any space that may expose employees to the risk of death, incapacitation or impairment of ability to self-rescue is considered to be a Permit Required Confined Space. This includes potential **hazardous atmospheres** such as:
 - a. Oxygen concentration below 19.5% or above 23.5%
 - b. Flammable gas
 - c. A toxic atmosphere or substance
 - d. Airborne combustible dust limiting visibility to 5' or less.
 - e. Any other known and recognized serious health or safety concern.

General Confined Space Entry Procedure

Confined spaces of all types exist throughout the District and throughout the Wastewater Treatment Plant and range from open trenches and manholes, to tanks, clarifiers and digesters. Contractors are required to meet Cal/OSHA safety standards for PERMIT REQUIRED CONFINED SPACE ENTRY OPERATIONS, Title 8 Article 108 Sections 5156-5158. and to provide a safe working environment for their employees.

All Contractors directing or working in confined spaces are required to notify the Authorized District Representative prior to starting the entry operation. The District shall provide to the contractor or subcontractor a copy of the confined space assessment for the space to be entered and meet and confer with the contractor and subcontractor to discuss the known and recognized hazards of the space and entry procedures.

Contractors are responsible for all operations, testing, equipment calibration, ventilation, and entry per the Cal/OSHA standards. Contractors are responsible for all confined

space permits and all appropriate entry procedures. A copy of completed confined space permits are to be turned in to the District's safety manager upon termination.

The following confined space entry procedures and rules shall be followed:

- a. An authorized person shall examine, test and evaluate the space before entry to determine that the appropriate precautions and PPE are available and will be used.
- b. There shall be no unauthorized entry into a confined space by any person.
- c. Top entries greater than 5' above the next level shall require fall protection.
- d. Once a top portal cover has been removed, the opening shall be guarded by a temporary guardrail system or other effective means to prevent employees from falling into the space.
- e. A rescue plan shall be developed and known by everyone involved in the entry.
- f. An attendant knowledgeable about the rescue plan shall be stationed outside the space. They will have a means of alerting first responders should the rescue plan be initiated.
- g. The attendant will **never** enter the confined space.
- h. Atmospheric testing and continuous monitoring shall be used to verify that conditions do not deteriorate beyond the capabilities of the control methods being used (ventilation or respiratory protection).
- i. Combustible compressed gas cylinders are not allowed in the confined space. Remove the torch from the space during breaks and at the end of the day. Changing torch heads or tips shall only be done outside the confined space.
- j. A 2-A:20-BC portable dry chemical fire extinguisher shall be available whenever hot work is being done in a confined space. Carbon monoxide extinguishers are not allowed.
- k. Retrieval equipment shall be worn by all entrants so that rescue can be initiated without anyone having to enter the space.
- l. The Las Gallinas Valley Sanitary District Confined Space Program Administrator will coordinate entry to all confined spaces and notification of San Rafael Fire Department prior to and after the entry is completed.
- m. The permit shall be closed out at the end of the workday by physically observing the space, ensuring that work is complete, and all employees have left the space.
- n. If work is necessary for more than one day, a new confined space permit must be completed and submitted.

Respiratory Protection Program Administration

Responsibility and authority for administration of a respiratory protection program is assigned to the employers Respiratory Protection Program Administrator. It is his/her responsibility to assure full compliance with all sections of this program and be in compliance with all requirements outlined in Cal/OSHA Title 8 CCR 5144 and related appendices.

Hazard Assessment

Proper assessment of the specific respiratory hazard is the first important step to determine what level of protection is required. Identification of the airborne contaminant in question, its physical state and concentration is required to determine proper protective measures.

Hazard Control

Hazard elimination shall be the primary goal. Wet methods, integrated dust collection systems, substitution, local and general exhaust systems and employee rotation are possible controls. When employees are anticipated to be exposed to harmful airborne contaminants beyond Permissible Exposure Limits (PEL), an appropriate NIOSH-approved respirator with proper filtration media shall be selected and used. The contractor or subcontractor is required to perform a job hazard analysis to identify hazards and engineering and administrative hazard controls. If the airborne contaminant hazard is not reduced to an acceptable level, respiratory protection must be used.

Respirator Selection

NIOSH-approved respirators will be selected based on the hazard assessment performed. Employees are prohibited from bringing their own respirators onto the worksite. Voluntary use of N95 filtering face-piece respirators (dust masks) for protection against dusts/mists, even though exposures are found to be below applicable exposure limits, is allowed as long as the employee has a medical evaluation, is trained and has read Appendix D of Title 8CCR 5144 and is aware of its limitations.

Medical Evaluation and Surveillance

Employees required to wear a respirator, including NIOSH approved N-95 filtering face piece, must be cleared by a Professional Licensed Health Care Provider (PLHCP) before being issued the equipment. Additional periodic evaluations, if deemed necessary due to respirator type, frequency of use or employee health, will be determined by physician's recommendation. Any employee that uses a respirator 30 or more days in a year for protection from airborne contaminants shall be enrolled in a Medical Surveillance Program.

Respirator Fit Testing

A qualitative or quantitative fit test will be performed annually on employees who wear negative-pressure respirators. This testing process will also allow the employee to become accustomed to the respirator prior to entering a hazardous atmosphere. Employees that are required to wear a NIOSH approved N-95 filtering face piece are

required to be fit tested. Fit testing shall be in compliance with Title 8CCR Section 5144 Appendix A.

Respirator Training

Each employee that uses a respirator will receive annual training that covers the following information:

- a. The hazardous nature of the air contaminant.
- b. Other hazard controls in effect and the reasons respirators are needed.
- c. The function, limitations, and capabilities of the respirator.
- d. The requirement that respirator users shall have no facial hair that interrupts the seal of the facepiece to the face or interrupts the function of valves.
- e. For filter type respirators, how to determine when the filter element needs to be changed.
- f. The potential consequences of overexposure caused by improper respirator use.
- g. How to check proper respirator fit before entering the area of exposure and why it is important to eliminate factors that can interfere with proper fit (beards, long sideburns, etc.).
- h. How and why to perform positive and negative pressure tests each time the respirator is donned.
- i. Procedures for proper cleaning, maintenance, and storage of the respirator.

Respirator Maintenance

Any employee using a respirator will clean and disinfect it at the end of each day it is used. During cleaning, inspect all parts for fit and deterioration. If deficiencies are found, the parts will be replaced, or a replacement respirator will be obtained. Respirators will be assigned to individual employees as required and will not be shared with anyone else.

Respirator Storage

The employee shall store the respirator in a clean, plastic, re-sealable bag or container after it has been cleaned and disinfected. The respirator will be stored in a temperate location 40 to 90 degrees F and not subjected to freezing conditions. It must be protected from physical damage or creasing from being struck or crushed by other tools or equipment. Chemical filters shall be stored separately from the face piece.

Respiratory Protection Program Review and Revision

This program will be evaluated annually for effectiveness annually. Incident records, including first aid logs, fit test records and training records will be reviewed to identify any illness or injury associated with respiratory protection. A representative sample of

supervisors and employees who have used respirators will be surveyed for their view on the program.

Trenching, Excavation and Shoring

All trenching, excavation and shoring activities shall be conducted under the direct supervision of a competent person and in accordance with Cal/OSHA Title 8 CCR Sections 1539-1541.1 and California Government Code 4216. The following requirements shall be followed:

- a. Prior to penetrating the surface, all utilities shall be marked by a qualified utility marking entity and in compliance with California Government Code 4216. Except in an emergency, digging shall not commence until utilities have been marked.
- b. All digging activities shall be conducted in a manner that reduces the chance of damaging subsurface utilities. The competent person shall identify the exact location of subsurface utilities throughout the dig and enforce the use of non-powered digging methods until the exact location has been established.
- c. Contractors and subcontractors shall report all damage to subsurface utilities, regardless if the excavator discovered or caused the damage.
- d. Prior to digging, a competent person shall conduct an inspection of the proposed dig site. This inspection shall include a survey of the surrounding area and a soil analysis consisting of at least one visual inspection and one manual analysis of soil samples.
- e. All trenches or excavations 5' or greater in depth shall be protected from cave in by shoring, shielding, benching, or sloping. Trenches or excavations less than 5' in depth shall be protected from cave-in using the methods mentioned above if there are signs of collapse.
- f. Trenches or excavations 20' or greater in depth shall have any protective system utilized designed under the supervision of a Professional Engineer registered in the State of California.
- g. The assigned competent person shall determine the protective system to be used when employees enter the excavation or trench.
- h. The excavator shall maintain on site any and all tabulated data used to make decisions for protecting employees entering the excavation or trench.
- i. The competent person shall conduct an inspection daily, prior to employees entering the excavation or trench to identify and remove hazards. Subsequent inspections shall be conducted after any hazard increasing occurrence such as a rainstorm.
- j. Access and egress shall be provided and positioned in trenches or excavations 4' or greater in depth and such that an employee shall not have to travel greater than 25' to access the route of access and egress. When ladders are used, the top of the ladder shall extend a minimum of 3' above the landing.

- k. Spoils piles and all other materials, equipment or supplies shall be staged no less than 2' from any trench or excavation wall.
- l. The competent person shall determine if there is potential for the development of a hazardous atmosphere in all trenches or excavations 4' or greater in depth.
- m. The competent person assigned to the excavation is responsible for all equipment required to dig safely and respond to anticipated emergencies.

Heat Illness Prevention

In California, employers must take steps to protect outdoor workers from heat illness with water, rest, shade and training. Heat illness prevention training is required for all outdoor workers and a written prevention plan must be available at all outdoor worksites. When outdoor temperatures are anticipated to reach the action level of 80 degrees Fahrenheit, contractors and subcontractors with exposed employees shall ensure the following:

- a. All exposed employees have access to and have been trained on the employers Heat Illness Prevention Program.
- b. Access to adequate supplies of suitably cool potable water.
- c. Access to shade. Shade is considered to be complete blockage of the sun.
- d. Cool down rest breaks are granted when requested by affected employees.

Temporary Traffic Controls

Contractors and subcontractors conducting temporary traffic controls shall do so in compliance with Cal/OSHA Title 8 CCR 1598-1599 and the California Manual on Uniform Traffic Control Devices (MUTCD). In some cases, an approved written Traffic Control Plan may be required. The following requirements shall be followed:

- a. All temporary traffic controls shall be planned by a qualified person and in advance to expedite gaining control of traffic and ensuring the required number and type of traffic control devices are present.
- b. All temporary traffic control devices shall be of the approved type as stipulated by the California Department of Transportation. All devices shall be of the appropriate dimensions and retro-reflectivity based on the speed of the work zone and hours of darkness.
- c. All temporary traffic control zones shall include the following component zones:
 - Advanced Warning Zone
 - Transition Zone
 - Activity Area with Buffer Zone
 - Termination Zone

- d. All temporary traffic control devices shall be maintained in usable condition and inspected periodically including but not limited to, signs, warnings, strobe lights, barricades, cones, and delineators.
- e. Personnel acting as flaggers shall be equipped with a STOP/SLOW paddle and dawn at minimum Class 3 retro-reflective high visibility apparel.
- f. A minimum of two flaggers shall be utilized for any lane closure. In this case, a lead flagger shall be identified.
- g. Any accident or emergency in the temporary traffic control zone shall be reported to 911 and District Management immediately.

General Safety Expectations

The following general safety performance expectations shall apply to all contractor and subcontractors work groups:

- a. Perform only those jobs to which you have been assigned and properly instructed. If you have any doubts or questions, ask your supervisor.
- b. Report damaged equipment immediately for replacement or repair.
- c. First aid will be administered only by trained authorized first responders.
- d. If any part of your body comes in contact with an acid or caustic substance, rush to the nearest water available and flush the affected part. Secure medical aid immediately.
- e. Keep your mind on your work at all times. Horseplay is not permitted on the job.
- f. Do not distract the attention of fellow workers. Do not engage in any act that would endanger another employee.
- g. Watch where you are walking. Do not run or take short cuts. Use only designated access routes to work areas.
- h. The use of illegal drugs or alcohol or being under the influence of the same on the project is cause for termination. Inform your supervisor if you are taking strong prescription drugs that warn against driving or using machinery.
- i. The employer provides sanitation facilities for your use. Damaging or defacing these facilities is forbidden.
- j. Serious injury can result when compressed air is used for personal cleaning or cooling. Use compressed air for equipment operation only.
- k. Keep all fire protection equipment and exits clear of obstructions to allow ready access.
- l. Riding on any material handling equipment not equipped with a seat and seat belt for each rider is prohibited and will be grounds for disciplinary action. Do not enter

any barricaded area unless you are authorized to do so and are wearing the proper required PPE.

- m. Never throw anything "overboard." Someone passing below may be seriously injured.

Hand and Portable Powered Tools

Each contractor or subcontractor shall be responsible for the safe condition of tools and equipment used by employees, including tools and equipment which may be furnished by employees. All tools shall be restricted to the use for which they are intended. Unsafe hand tools shall not be used. The following rules apply to the use of hand and portable powered tools:

- a. Keep tools clean, free of grease and dirt. Clean tools work better and last longer. Poorly maintained tools are less efficient and may cause damage or injuries.
- b. Red tag defective tools for repair.
- c. Do not use power tools and equipment until you have been properly instructed in the safe work methods and are given authority to use them.
- d. Do read and understand the manufacturer's recommendations for safe use of the tool including the recommendations for PPE.

Safe Use of Portable Ladders

The following specific requirements apply to portable ladder safety. Use of portable ladders shall comply with Cal/OSHA Title 8 CCR Section 3276:

- a. Training in the safe use of portable ladders is required for all contractor and subcontractor employees that use them.
- b. For any overhead work near electrical sources, use an appropriate ladder for the task (fiberglass). Metal ladders must not be used when working on or near electrical circuits.
- c. Maintain a minimum of 10' clearance distance from any energized systems or equipment.
- d. Straight or extension ladders should have non-skid feet or be cleated. Secure ladders by lashing at the top and blocking at the bottom if there is chance of slippage.
- e. Set up straight or extension ladders at 75.5 degrees using the label on the side rail or measuring one foot out for every four feet of length (the 4:1 rule). Only use ladders on a firm, level, and stable base, not on lumber, masonry block or other insecure materials. Never set up a ladder on a scaffold or other elevated work platform.
- f. Never climb on the two highest rungs of a step, straight or extension ladder, or sit or stand on the top cap of an "A" frame ladder.

- g. When straight ladders are used to access a work platform, the top must extend at least 3 feet above the landing, deck or roof area.
- h. Remove defective ladders from service and tag “*Dangerous, Do Not Use.*”
- i. Inspect the ladder for defects (missing cleats, cracked rungs, broken spreaders, etc.) before use. Do not use a defective ladder. Position ladders away from doors unless door is blocked, locked or guarded to prevent it from striking the ladder.
- j. Stepladders will be used only when fully open with both spreader bars locked and on firm and level surface. Do not use a stepladder in the closed or semi-closed position or as a lean-to ladder.
- k. Climb the front steps (not rear braces) of a stepladder. Always face the ladder when climbing or working.
- l. Maintain three points of contact at all times when ascending or descending the ladder.
- m. Never walk an “A” frame ladder or jump a straight ladder.

Housekeeping

During the course of construction, alteration, or repairs, form and scrap lumber with protruding nails and all other debris shall be kept reasonably cleared from work areas, passageways, and stairs in and around buildings or other structures. The following housekeeping rules shall apply at all times:

- a. Dispose of oily rags, old paint cans and other containers that have held flammable liquids in the appropriate labeled receptacle.
- b. Throw debris and scrap in properly labeled waste containers. Do not place combustibles or flammables in open containers.
- c. Identify slip, trip and fall hazards in the work area and control them.
- d. Practice good housekeeping around your work area. Everyone must look after their own area and report other areas in need of attention to the supervisor promptly.

9.0 SAFETY COMMUNICATIONS

At minimum Cal/OSHA requires all employers to provide a system of communication regarding safety issues, concerns and identified hazards. Employees that bring these concerns to their employer shall do so without fear of reprisal. In a multiemployer work environment, the host employer and the contractor or subcontractor commit to a program that will provide the same level of safety and health protection to temporary and contract workers as to permanent workers. Before the start of any on-site work, the host employer and contractor or subcontractor, establish their respective safety and health responsibilities and obligations, as well as procedures for coordinating these

responsibilities and communicating safety and health information, employee training and education.

The key elements of safety communication include:

- Management leadership
- Worker participation
- Hazard identification and assessment
- Hazard prevention and control
- Employee training and education
- Program evaluation

10.0 INJURY AND ILLNESS REPORTING

It is the policy of the Las Gallinas Valley Sanitary District that all employees report any and all occupational related injury or illness to their supervisors immediately. Supervisors shall document and investigate all reported injuries and illnesses and provide guidance to the employee in seeking medical attention beyond basic first aid.

Employers shall report immediately by telephone to the nearest District Office of the Division of Occupational Safety and Health any serious injury or illness, or death, of an employee occurring in a place of employment or in connection with any employment. If a contractor is injured, the contractor's employer must notify Cal/OSHA.

Immediately means as soon as practically possible, but not longer than 8 hours after a manager or higher knows or with diligent inquiry would have known of the death or serious injury or illness.

A serious injury is defined as: any injury or illness occurring in a place of employment or in connection with any employment that requires inpatient hospitalization for other than medical observation or diagnostic testing, or in which an employee suffers an amputation, the loss of an eye, or any serious degree of permanent disfigurement, but does not include any injury or illness or death caused by an accident on a public street or highway, unless the accident occurred in a construction zone.

11.0 PERIODIC INSPECTIONS

Periodic inspections are designed to ensure that the Code of Safe Practices is being followed and to help identify new or previously unrecognized hazards. Inspection reports will be provided to the Las Gallinas Valley Sanitary District Facility Management for the inspected area(s). All safety violations, hazards and safety concerns observed will be documented. Use of an inspection check list aids in recordkeeping.

Supervisors will conduct a morning safety walk through of their employee primary area(s) and equipment to ensure it is in safe condition. Each morning, supervisors will review with their work crews any hazards associated with work to be performed that day.

Supervisors will document periodic safety inspections of their area and may include items on the below list. In some cases, the inspection shall be conducted by a competent person or qualified person. The following inspections shall be performed:

Required Inspection Frequency	
Fire Extinguisher	<i>Monthly</i>
Eye Wash Station	<i>Monthly</i>
Emergency Shower	<i>Monthly</i>
Forklift/Scissor Lift/Aerial Lift	<i>Pre-shift or pre use</i>
Hazardous Waste Containers	<i>Weekly</i>
Respirator	<i>Pre use</i>
Fall Protection Equipment	<i>Semi-annually & pre use</i>
Confined Space Equipment	<i>Per Equipment Manufacturer</i>
Portable Ladders	<i>Pre use</i>
Scaffold System	<i>Daily Prior to Employee Access</i>
Trench/Excavation	<i>Daily Prior to Employee Access. After Any Hazard Increasing Occurrence</i>
Work Areas	<i>Daily before work begins</i>

Managers and Supervisors shall conduct inspections as often as possible and at intervals sufficient to ensure safe and sanitary working conditions are maintained at all times.

12.0 HAZARD IDENTIFICATION AND CORRECTION

Hazard identification and assessment means that all contractors or subcontractors shall:

- a. Collect and review information about the hazards likely to be present in the workplace.
- b. Periodically inspect the workplace to identify new or recurring hazards.
- c. Investigate injuries, illnesses, incidents, and close calls/near misses to identify the underlying hazards.
- d. Identify and address any trends in injuries, illnesses, and hazard reports. Consider hazards associated with emergency or non-routine situations.
- e. Determine the severity and likelihood of incidents that could result from each hazard identified and use this information to prioritize corrective actions.

Note: employers have an ongoing obligation to control serious, recognized hazards.

13.0 RECORDKEEPING REQUIREMENTS

Record	Minimum Retention (yrs)	Code citation
Workplace inspections	1	8CCR3203(b)(1)

Training records (See below for exceptions)	1	8CCR3203(b)(2)
Safety committee meeting records	1	8CCR3203(c)(2)
Accident investigation records	None	
OSHA300, 300A, 301	5	8CCR14300.33
Employee medical records	Termination of employment + 30 yrs	8CCR3204(d)(1)(A)
Employee exposure records (Includes all workplace monitoring data, MSDSs, Chemical inventories)	"At least" 30 yrs	8CCR3204(d)(1)(B)
Bloodborne Pathogens Training	3	8CCR5193(h)(2)(B)
Sharps injury log	5	8CCR5193(h)(3)
Hazwaste manifest receipts	3	HSC25160.2(b)(3)&(4)
Asbestos training records	Termination of employment + 1 year	8CCR1529(n)(4)
Notification of identification, location and quantity of asbestos	Duration of ownership of building; must be transferred to new owner	8CCR1529(n)(6)
Noise exposure measurements	2	8CCR5100(d)(1)
Audiometric test records	Duration of employment	8CCR5100(d)(2)
Maintenance of fire extinguishing systems	5	19CCR904.1(b)
MSDS & SDS, and employee hazardous material exposure records	30 years	8,CCR 5194
Reports of testing on mechanical ventilation systems such as fume hoods	5 yrs	8 CCR 5143
Reports of testing on HVAC systems for building ventilation	5 yrs	8 CCR 5142(b)(2)

14.0 PERIODIC PROGRAM EVALUATION

Program evaluation and improvement means that the Las Gallinas Valley Sanitary District Facility Management will:

- a. Establish, report, and track metrics that indicate whether the program is effective.
- b. Evaluate the overall program, initially and periodically, to identify deficiencies and opportunities for improvement.
- c. Monitor progress and performance of contractors or subcontractors.
- d. Verify that the program is implemented and is operating.
- e. Correct program deficiencies and identify opportunities to improve.

Appendix A- Wastewater Treatment Plant Map

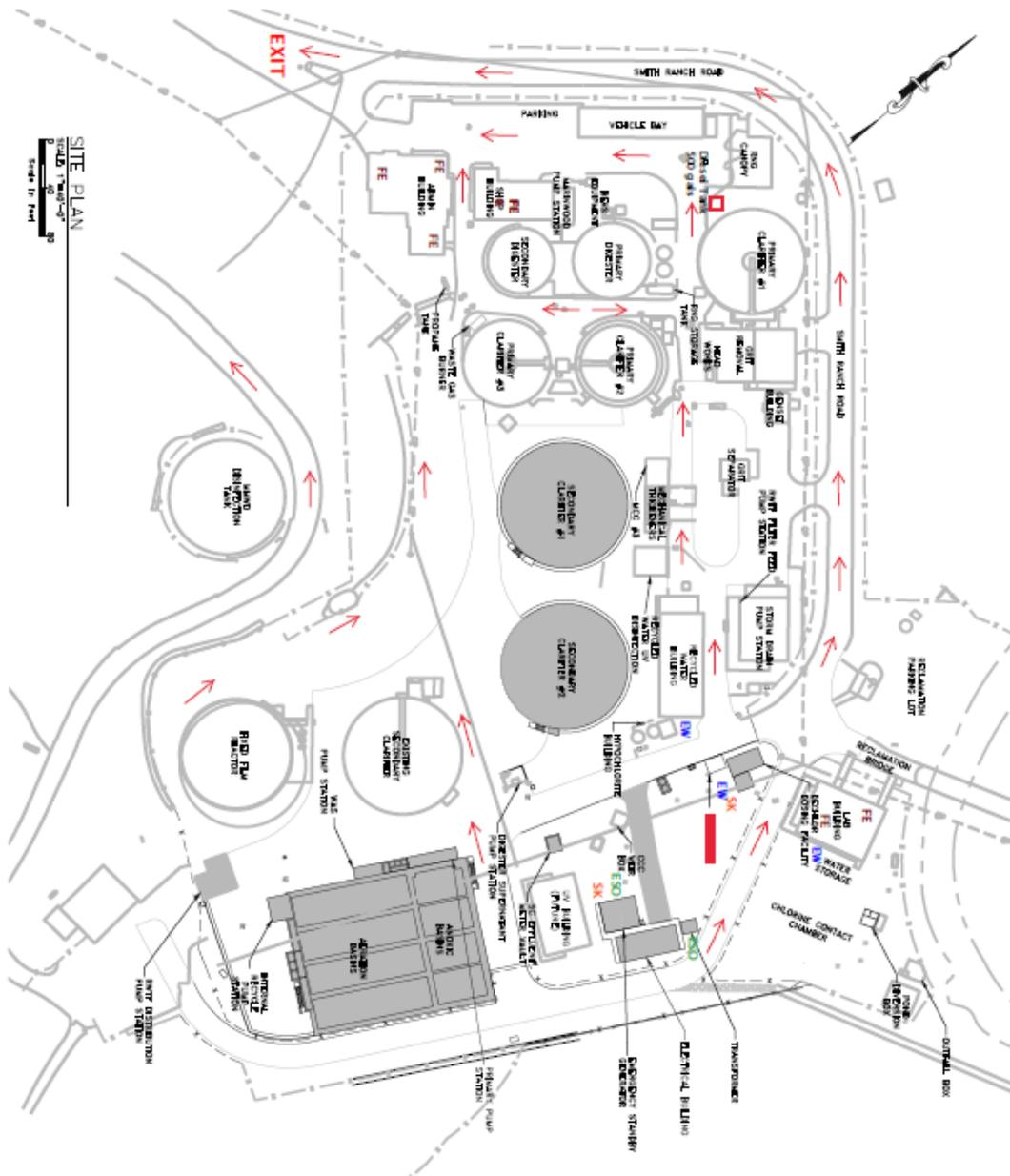

- Legend**
- EW = Eyewash/ Shower Station
 - SK = Spill Kit
 - FE = Fire Extinguisher
 - ESO = Emergency Showoff

Appendix B- Definitions

Appendix B- Definitions

PARTS AND MATERIALS:

All products, materials, devices, systems, or installations installed by Contractor shall have been approved, listed, labeled, or certified as conforming to applicable governmental or other nationally recognized standards, or applicable scientific principles. The listing, labeling, or certification of conformity shall be based upon an evaluation performed by a person, firm, or entity with appropriate registered engineering competence; or by a person, firm, or entity, independent of the manufacturer or supplier of the product, with demonstrated competence in the field of such evaluation.

CONTRACTOR:

Designates “Contractor”, “Contractors”, “Sub-Contractors”, “Suppliers”, and all employees of each.

AUTHORIZED DISTRICT REPRESENTATIVE:

The District’s Authorized Representatives shall be the employee(s) designated by the District to be responsible for communicating with the Contractor or subcontractor.

COMPETENT PERSON:

One who is capable of identifying existing and predictable hazards in the surroundings or working conditions which are unsanitary, hazardous, or dangerous to employees, and who has authorization to take prompt corrective measures to eliminate them.

QUALIFIED PERSON:

Qualified Person, Attendant or Operator. A person designated by the employer who by reason of training, experience or instruction has demonstrated the ability to safely perform all assigned duties and, when required, is properly licensed in accordance with federal, state, or local laws and regulations.

DISTRICT JURISDICTION:

For the purposes of these regulations, “District” Shall mean the Las Gallinas Valley Sanitary District.

TREATMENT PLANT AND FACILITIES:

For the purposes of these regulations, “Treatment Plant & Facilities” shall include the District's Wastewater Treatment Plant, lift stations and sewage conveyance systems located within the boundaries of the District.

Exhibit E

Contractor's License & Workers' Compensation Insurance Info

Exhibit F

**Performance Bond, Payment/Labor and Materials Bond,
and Maintenance Bond**

LAS GALLINAS VALLEY SANITARY DISTRICT
101 Lucas Valley Road, Suite 300
San Rafael, California 94903

PERFORMANCE BOND

BOND NO. _____

PREMIUM: _____

KNOW ALL MEN BY THESE PRESENTS:

WHEREAS, LAS GALLINAS VALLEY SANITARY DISTRICT, (hereinafter designated as "Obligee") and _____ (hereinafter designated as "Principal") have entered into an agreement whereby principal agrees to install and complete certain designated public IMPROVEMENT, which said agreement, dated _____, and identified as project _____, is hereby referred to and made a part hereof; and

WHEREAS, Said principal is required under the terms of said agreement to furnish a bond for the faithful performance of said agreement;

NOW, THEREFORE, We, the principal and _____ as surety, are held and firmly bound unto the hereinafter called "The Obligee," in the penal sum of _____ dollars (\$ _____) lawful money of the United States for the payment of which sum well and truly to be made, we bind ourselves, our heirs, successors, executors and administrators, jointly and severally firmly by these presents.

The condition of this obligation is such that if the above bound principal, his or its heirs, executors, administrators, successors or assigns, shall in all things stand to and abide by, and well and truly keep and perform the covenants, conditions and provisions in the said agreement and any alteration thereof made as therein provided, on his or their part, to be kept and perform and at the time and in the manner therein specified, and in all respects according to their true intent and meaning, and shall indemnify and save harmless the Obligee, its officers, agents and employees, as therein stipulated, then this obligation shall become null and void; otherwise it shall be and remain in full force and effect.

As part of the obligation secured hereby and in addition to the face amount specified therefore, there shall be included costs and reasonable expenses and fees, including reasonable attorney's fees, incurred by county in successfully enforcing such obligation, all to be taxed as costs and included in any judgment rendered.

The surety hereby stipulates and agrees that no change, extension of time, alteration or addition to the terms of the agreement or to the work to be performed thereunder or the specification accompanying the same shall in any wise affect its obligations on this bond, and it does hereby waive notice of any such change, extension of time, alteration or addition to the terms of the agreement or to the work or to the specifications.

IN WITNESS WHEREOF, the above-bound parties have executed this instrument under their

several seals this _____ day of _____, the name and corporate seals of each corporate party being hereto affixed and these presents duly signed by their undersigned representatives, pursuant to authority of their governing bodies.

(Corporate Seal)

PRINCIPAL

(Acknowledgement)

By: _____
Title: _____

(Corporate Seal)

SURETY

(Acknowledgement)

By: _____

(Attorney-in-fact)

Title: _____

(NOTE TO SURETY COMPANY: A certified copy of unrevoked resolution of authority for the attorney-in-fact must be submitted with and attached to the executed bid bond.)

LAS GALLINAS VALLEY SANITARY DISTRICT
101 Lucas Valley Road, Suite 300
San Rafael, California 94903

PAYMENT/LABOR AND MATERIALS BOND

BOND NO.: _____

KNOW ALL MEN BY THESE PRESENTS:

That we, _____ Principal, and _____, incorporated under the laws of the State of _____ and authorized to execute bonds and undertakings as sole surety, as Surety, are held and firmly bound unto any and all persons named in California Civil Code Section 1181 whose claim has not been paid by the contractor, company or corporation, in the aggregate total of _____ dollars (\$ _____), for the payment whereof, well and truly to be made, said Principal and Surety bind themselves, their heirs, administrators, successors and assigns, jointly and severally, firmly by these present.

The Condition of the foregoing obligation is such that; whereas the above bounden Principal has entered into a contract, dated _____, with the LAS GALLINAS VALLEY SANITARY DISTRICT to do the following work, to-wit: _____.

NOW, THEREFORE, if the above bounden Principal contractor, person, company or corporation, or his or its subcontractor, fails to pay any claimant named in Section 3181 of the Civil Code of the State of California, or amounts due under the Unemployment Insurance Code, with respect to work or labor performed by any such claimant, that, the Surety on this bond will pay the same, in an amount not exceeding the aggregate sum specified in this bond, and also in case suit is brought upon this bond, a reasonable attorney's fee, which shall be awarded by the court to the prevailing party in said suit, said attorney's fee to be taxes as costs in said suit. This bond shall inure to the benefit of any person named in Section 3181 of the Civil Code of the State of California so as to vie a right of action to them or their assignees in any suit brought upon this bond.

This bond is executed and filed to comply with the provisions of the act of Legislature of the State of California as designated in Civil Code Sections 3247-3252 inclusive, and all amendments thereto.

IN WITNESS WHEREOF, the above-bound parties have executed this instrument under their several seals this _____ day of _____, _____ the name and corporate seals of each corporate party being hereto affixed and these presents duly signed by their undersigned representatives, pursuant to authority of their governing bodies.

(Corporate Seal)

PRINCIPAL

(Acknowledgement)

By:
Title: _____

(Corporate Seal)

SURETY

By: _____

(Attorney-in-fact)

(Acknowledgement)

Title: _____

(NOTE TO SURETY COMPANY: A certified copy of unrevoked resolution of authority for the attorney-in-fact must be submitted with and attached to the executed bid bond.)

LAS GALLINAS VALLEY SANITARY DISTRICT
101 Lucas Valley Road, Suite 300
San Rafael, California 94903

MAINTENANCE BOND

KNOW ALL MEN BY THESE PRESENTS:

WHEREAS the Board of the Las Gallinas Valley Sanitary District (designated as the "OBLIGEE"), has awarded to _____, (designated as the "PRINCIPAL") a contract for the _____ project, Job No. _____, which contract and all of the Contract Documents as defined therein (designated as the "Contract") are hereby made a part hereof;

WHEREAS, the PRINCIPAL is required under the terms of the Contract to furnish a bond for the correction of any defects due to defective materials or workmanship in the work performed under the Contract, for a period of TWO (2) YEARS from the date of acceptance by the OBLIGEE of the contracted work.

NOW, THEREFORE, we the PRINCIPAL and the undersigned _____, as surety (designated as "SURETY"), an admitted surety insurer authorized to do business in the State of California, are held and firmly bound unto the Las Gallinas Valley Sanitary District, in the penal sum of _____ Dollars (\$_____), lawful money of the United States, being a sum not less than ten percent (10%) of the final Contract price, for the payment of which sum well and truly to be made, we bind ourselves, our heirs, executors, administrators, successors, and assigns jointly and severally, firmly by these presents.

THE CONDITIONS OF THIS OBLIGATION ARE SUCH that if, during a maintenance period of TWO (2) YEARS from the date of acceptance by the OBLIGEE of the contracted work, the PRINCIPAL upon receiving written notice of a need for repairs which are directly attributable to defective materials or workmanship, shall diligently take the necessary steps to correct said defects within seven (7) calendar days from the date of said notice, then this obligation shall be null and void; otherwise it shall remain in full force and effect.

If any action shall be brought by the OBLIGEE upon this bond, a reasonable attorney's fee, to be fixed by the Court, shall be and become a part of OBLIGEE's judgment in any such action. No right of action shall accrue on this bond to, or for the use of, any person or corporation other than the OBLIGEE named herein or the heirs, executors, administrator or successor of the OBLIGEE.

IN WITNESS WHEREOF, the above bound parties have executed this instrument under their seals this _____ day of _____, _____, the name and corporate seals of each corporate party being hereto affixed and these presents duly signed by its undersigned representative, pursuant to authority of its governing body.

(Corporate Seal)

PRINCIPAL

(Acknowledgement)

By: _____
Title: _____

(Corporate Seal)

SURETY

(Acknowledgement)

By: _____

(Attorney-in-fact)
Title: _____

(NOTE TO SURETY COMPANY: A certified copy of unrevoked resolution of authority for the attorney-in-fact must be submitted with and attached to the executed bid bond)

TECHNICAL SPECIFICATIONS (Not Used)

AS-BUILT DRAWINGS & REFERENCE PHOTO

**AS-BUILT DRAWINGS
SHEET 1 OF 2**

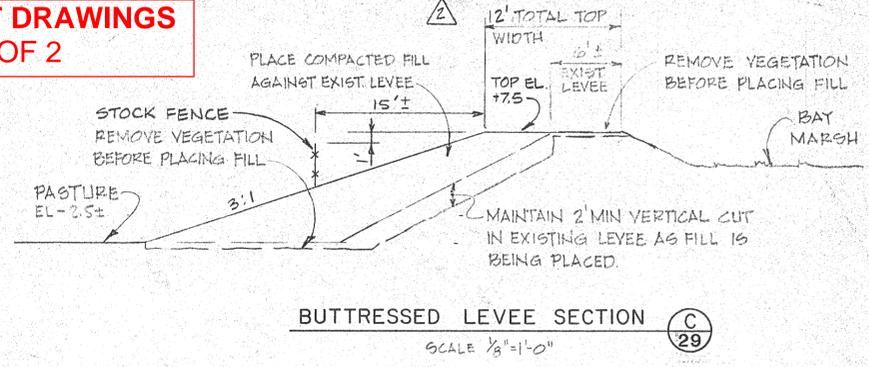
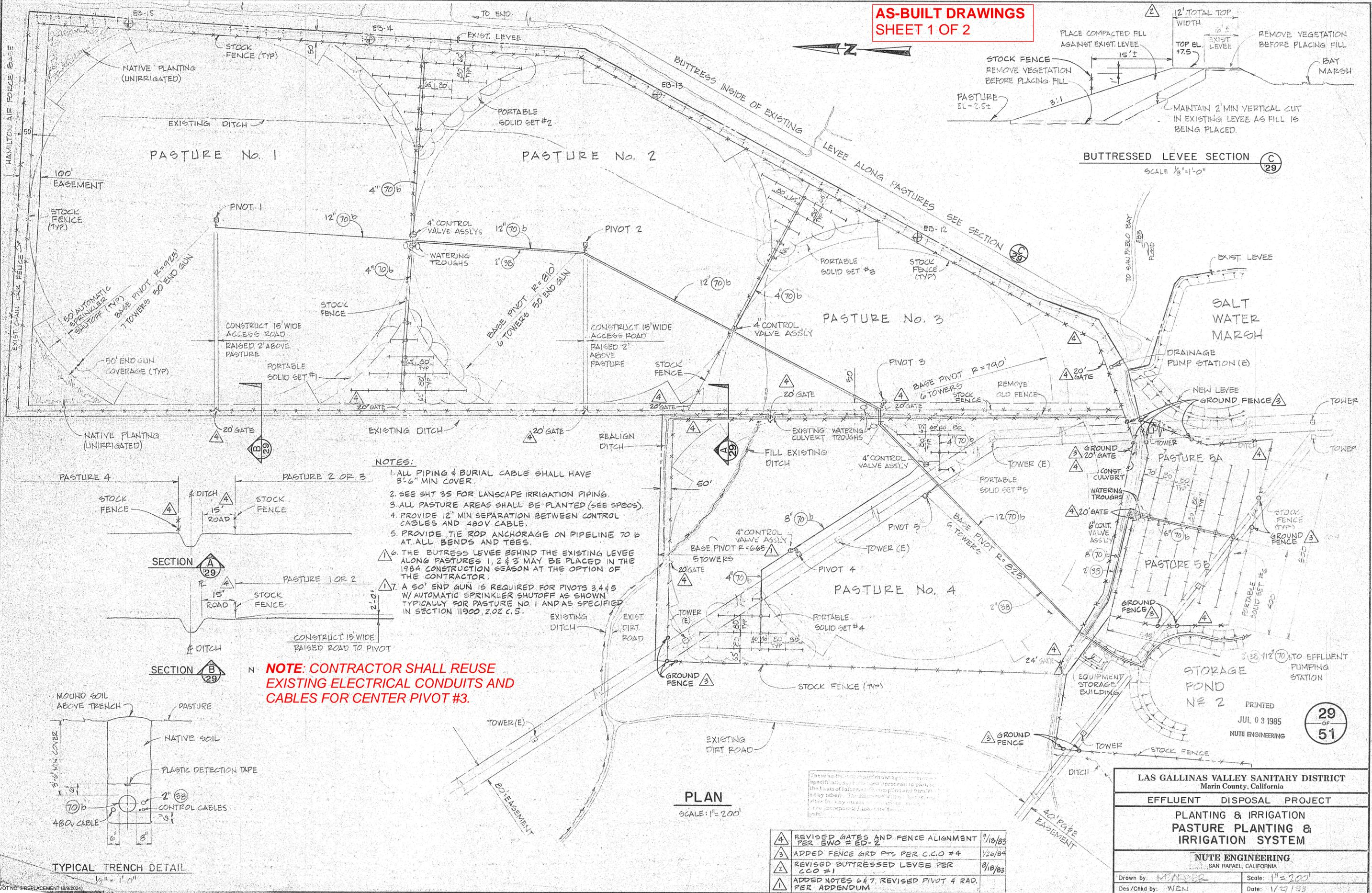

- NOTES:**
1. ALL PIPING & BURIAL CABLE SHALL HAVE 3'-6" MIN COVER.
 2. SEE SHT 35 FOR LANDSCAPE IRRIGATION PIPING.
 3. ALL PASTURE AREAS SHALL BE PLANTED (SEE SPECS).
 4. PROVIDE 12" MIN SEPARATION BETWEEN CONTROL CABLES AND 480V CABLE.
 5. PROVIDE TIE ROD ANCHORAGE ON PIPELINE 70 b AT ALL BENDS AND TEES.
 6. THE BUTTRESS LEVEE BEHIND THE EXISTING LEVEE ALONG PASTURES 1, 2 & 3 MAY BE PLACED IN THE 1984 CONSTRUCTION SEASON AT THE OPTION OF THE CONTRACTOR.
 7. A 50' END GUN IS REQUIRED FOR PIVOTS 3, 4 & 5 W/ AUTOMATIC SPRINKLER SHUTOFF AS SHOWN TYPICALLY FOR PASTURE NO. 1 AND AS SPECIFIED IN SECTION 11900, 2.02 C.S.

NOTE: CONTRACTOR SHALL REUSE EXISTING ELECTRICAL CONDUITS AND CABLES FOR CENTER PIVOT #3.

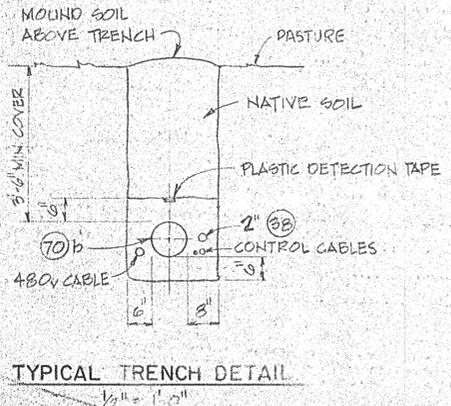
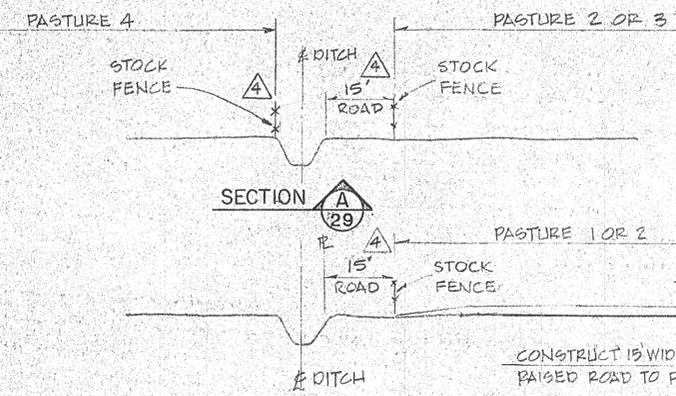

PLAN
SCALE: 1" = 200'

4	REVISED GATES AND FENCE ALIGNMENT PER EWO # ED-2	9/10/83
3	ADDED FENCE GRD PTS PER C.C.O #4	1/26/84
2	REVISED BUTTRESSED LEVEE PER CCO #1	8/18/83
1	ADDED NOTES 6 & 7, REVISED PIVOT 4 RAD. PER ADDENDUM	

LAS GALLINAS VALLEY SANITARY DISTRICT
Marin County, California

EFFLUENT DISPOSAL PROJECT

**PLANTING & IRRIGATION
PASTURE PLANTING &
IRRIGATION SYSTEM**

NUTE ENGINEERING
SAN RAFAEL, CALIFORNIA

Drawn by: *WEN* Scale: 1" = 200'
Des/Chkd by: *WEN* Date: 1/27/83

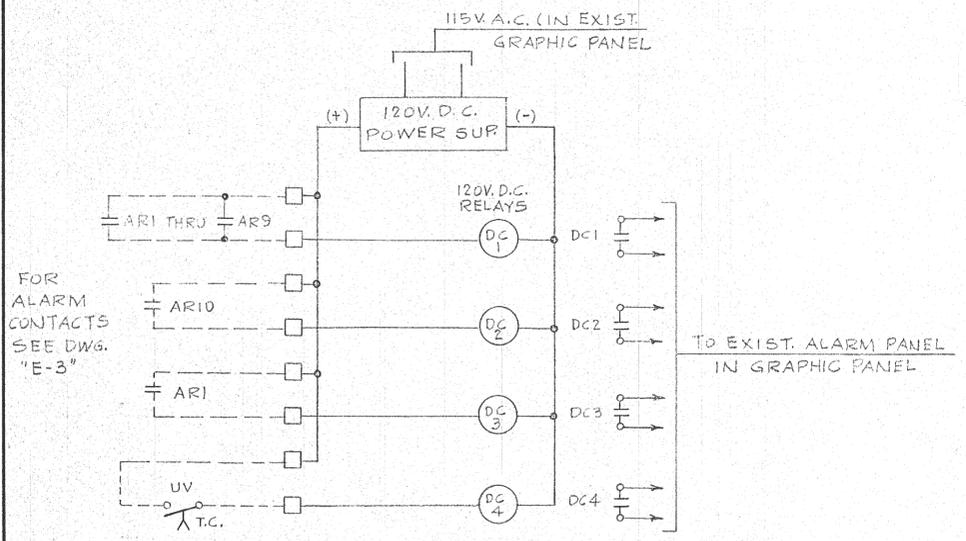
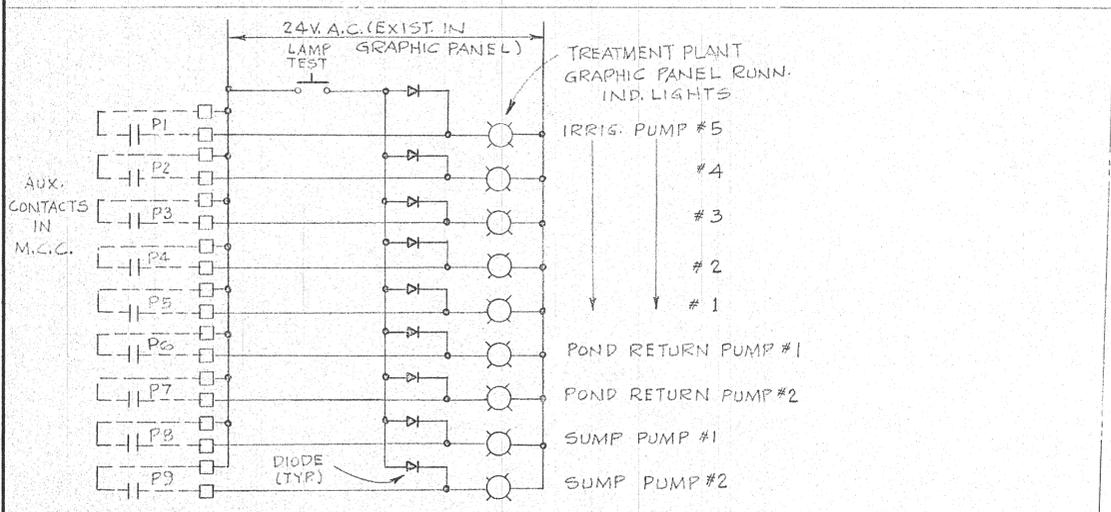
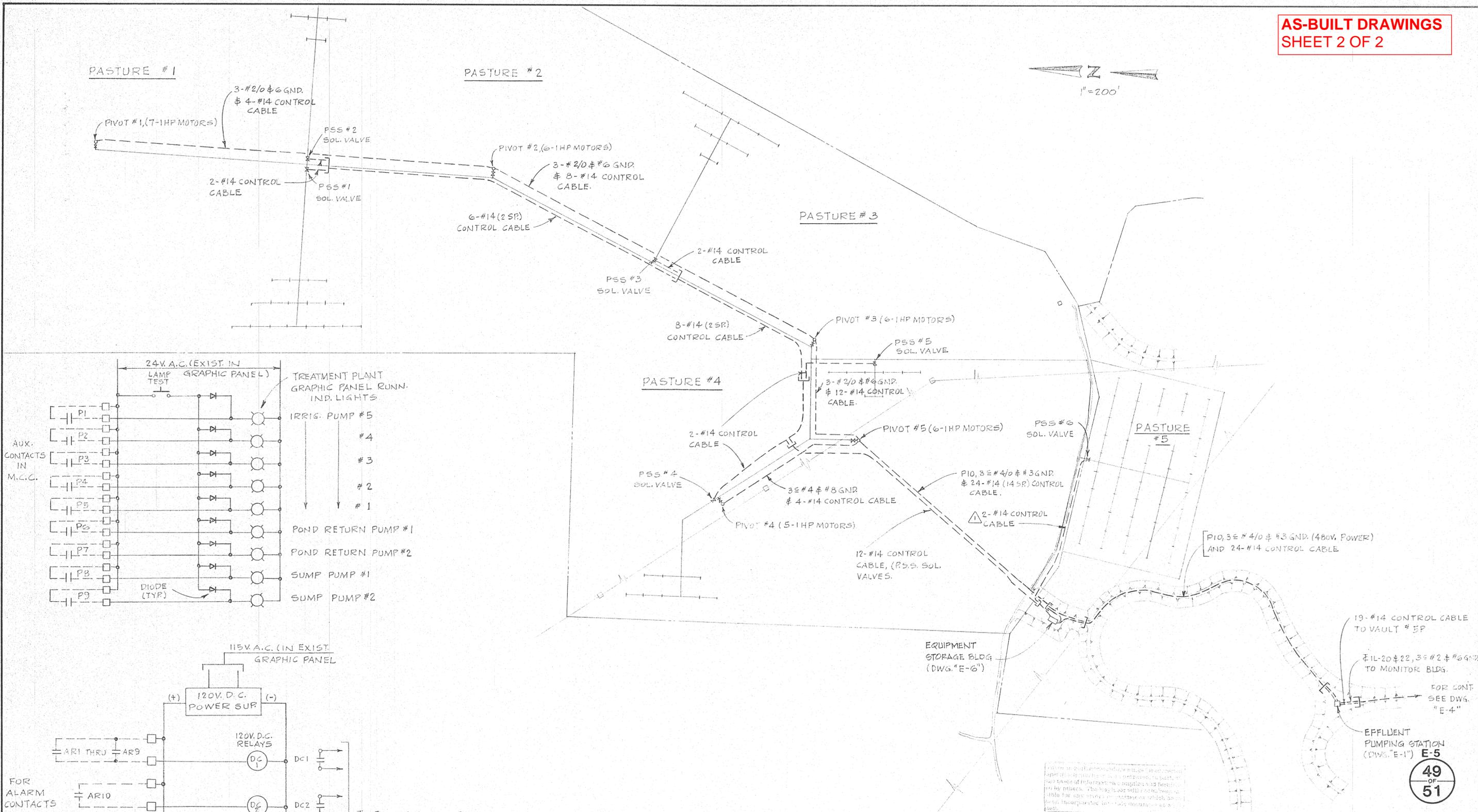
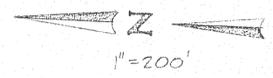

LAS GALLINAS VALLEY TREATMENT PLANT
GRAPHIC PANEL ADDITIONS

THIS DRAWING IS THE PROPERTY OF NUTE ENGINEERING. IT IS TO BE USED ONLY FOR THE PROJECT AND SITE SPECIFICALLY IDENTIFIED HEREON. IT IS NOT TO BE REPRODUCED, COPIED, OR TRANSMITTED IN ANY FORM OR BY ANY MEANS, ELECTRONIC OR MECHANICAL, INCLUDING PHOTOCOPYING, RECORDING, OR BY ANY INFORMATION STORAGE AND RETRIEVAL SYSTEM, WITHOUT THE WRITTEN PERMISSION OF NUTE ENGINEERING.

PRINTED
JUL 03 1985
NUTE ENGINEERING

49
OF
51

AS BUILT	
LAS GALLINAS VALLEY SANITARY DISTRICT Marin County, California	
EFFLUENT DISPOSAL PROJECT	
ELECTRICAL WORK	
SITE PLAN - PASTURE	
NUTE ENGINEERING SAN RAFAEL, CALIFORNIA	
Drawn by: EM	Scale: 1" = 200'
Des/Chkd by: WEN	Date: 1/27/83

PHOTO OF EXISTING PIPING MODIFICATIONS AT CENTER PIVOT #2



*NOTE: FOR REFERENCE ONLY.
CENTER PIVOT #3 PIPING MODIFICATIONS MAY REQUIRE
SIMILAR INSTALLATION AS CENTER PIVOT #2.*

07 20 2020